



UNIVERSITÀ DI PAVIA
Dipartimento di
Ingegneria Industriale
e dell'Informazione

Carla Vacchi

carla.vacchi@unipv.it

Ricercatore Universitario
Docente Elettronica



UNIVERSITÀ DI PAVIA
Dipartimento di
Ingegneria Industriale
e dell'Informazione

Progetto per la diffusione della **SCIENZA** dai 5 anni in su

STEM

STEAM

Science: chimica biologia astronomia **fisica** ... (scienze sociali?)

Technology
Engineering } elettromagnetismo, elettronica, fotonica,
informatica

Arts colore, strumenti musicali

Mathematics geometria e giochi per i più piccoli



SALA MUSEO



ondivaghiamo

LABORATORIO DIDATTICO DI ELETTRONICA

PF Manfredi



UNIVERSITÀ DI PAVIA
Dipartimento di
Ingegneria Industriale
e dell'Informazione



Elettronica e Fotonica: due mondi che interagiscono

Elettronica

Studia l'emissione, propagazione e rivelazione degli elettroni

Progettazione e realizzazione di sistemi hardware in grado di elaborare segnali che rappresentano informazioni

1904 diodo a vuoto

Fotonica

Studia l'emissione, propagazione e rivelazione dei fotoni

Progettazione e realizzazione di sistemi hardware in grado di elaborare segnali che rappresentano informazioni

1960 LASER

il fotone

- l'onda e.m. trasporta energia
- l'energia è trasportata in pacchetti discreti e indivisibili (quanti)
- il quanto di energia luminosa è il fotone

il fotone è una particella di massa nulla

energia di un fotone

$$E = h\nu$$

ν è la frequenza dell'onda elettromagnetica

h = costante di Plank = $6,6 \cdot 10^{-34}$ Js

Esempio radiazione con $\lambda_{\text{vuoto}} = 450$ nm

$$\begin{aligned} E_{\text{fotone}} &= 6.6 \cdot 10^{-34} \text{ Js} \times (3 \times 10^8 \text{ m/s}) / (450 \times 10^{-9} \text{ m}) = \\ &= 4,4 \times 10^{-19} \text{ J} \end{aligned}$$

Elettronica e Fotonica: due mondi che interagiscono

Dispositivi Optoelettronici

Dispositivi elettronici che interagiscono con la luce*

*luce in senso lato: radiazione infrarossa, visibile e ultravioletta, raggi X e raggi gamma

Onde elettromagnetiche

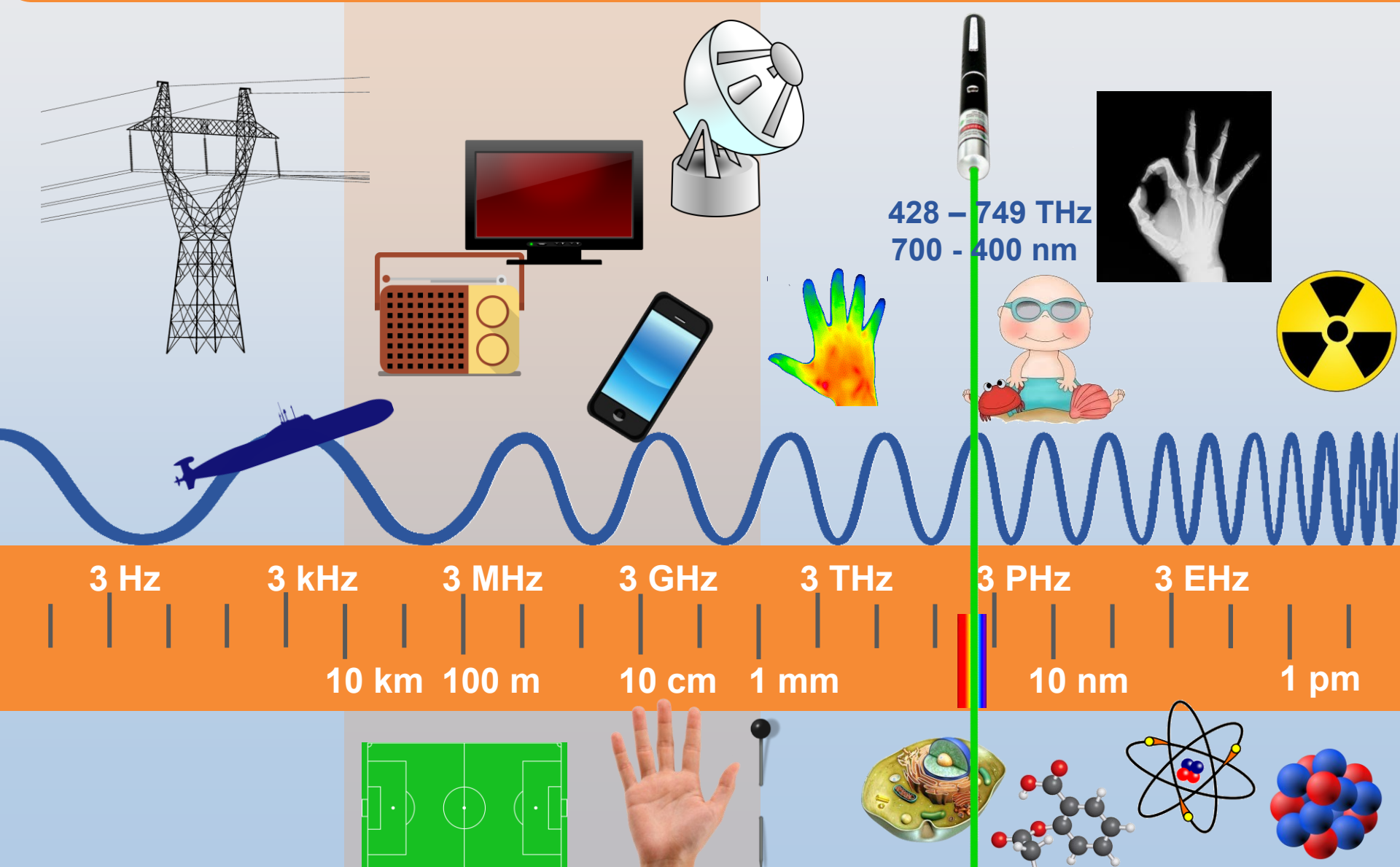

Dispositivi Optoelettronici: principi fisici

Fotoconduttività (fotoresistore, tubo a camera fotoconduttiva, charge-coupled imaging devices)

Effetto Lossev o combinazione radiativa (LED)

Effetto Fotoelettrico o Fotovoltaico (fotodiodi, fototransistori, fotomoltiplicatori, circuiti ottici integrati)

Emissione Stimolata (LASER, diodo LASER)

Fotoemissività (tubo a camera fotoemissiva)

Attività ottica (LCD)

.....

Premesse

Nella meccanica quantistica gli elettroni vengono rappresentati mediante una funzione d'onda Ψ

$|\Psi|^2$ rappresenta la probabilità di trovare un elettrone in una data posizione

Nei solidi è conveniente utilizzare la teoria della struttura elettronica a bande, che permette di spiegare molte caratteristiche fisiche

????

In un atomo isolato gli elettroni occupano gli orbitali atomici, caratterizzati da livelli di energia discretizzati

In una molecola, gli orbitali degli atomi si sovrappongono e assumono forme ibride

In un solido cristallino formato da N atomi, gli orbitali di ciascun atomo si sovrappongono a quelli degli atomi vicini, i livelli di energia diventano N livelli con energie molto vicine (bande di energia)

La struttura elettronica a bande spiega bene

- la resistività dei materiali
- l'interazione con la luce
- i dispositivi a semiconduttore

Il materiale deve essere infinito, omogeneo, e l'elettrone non interagisce con altri elettroni, con il cristallo etc etc

Livello di Fermi (μ o E_F)

Il livello di energia di Fermi serve per calcolare la probabilità che un dato stato di energia E sia occupato

$$f(\epsilon) = \frac{1}{e^{(\epsilon - \mu)/kT} + 1}$$

Se c'è uno stato al livello Fermi, ha probabilità pari al 50% di essere occupato



tavola di Mendeleev

TAVOLA PERIODICA DEGLI ELEMENTI

<http://www.periodni.com/it/>

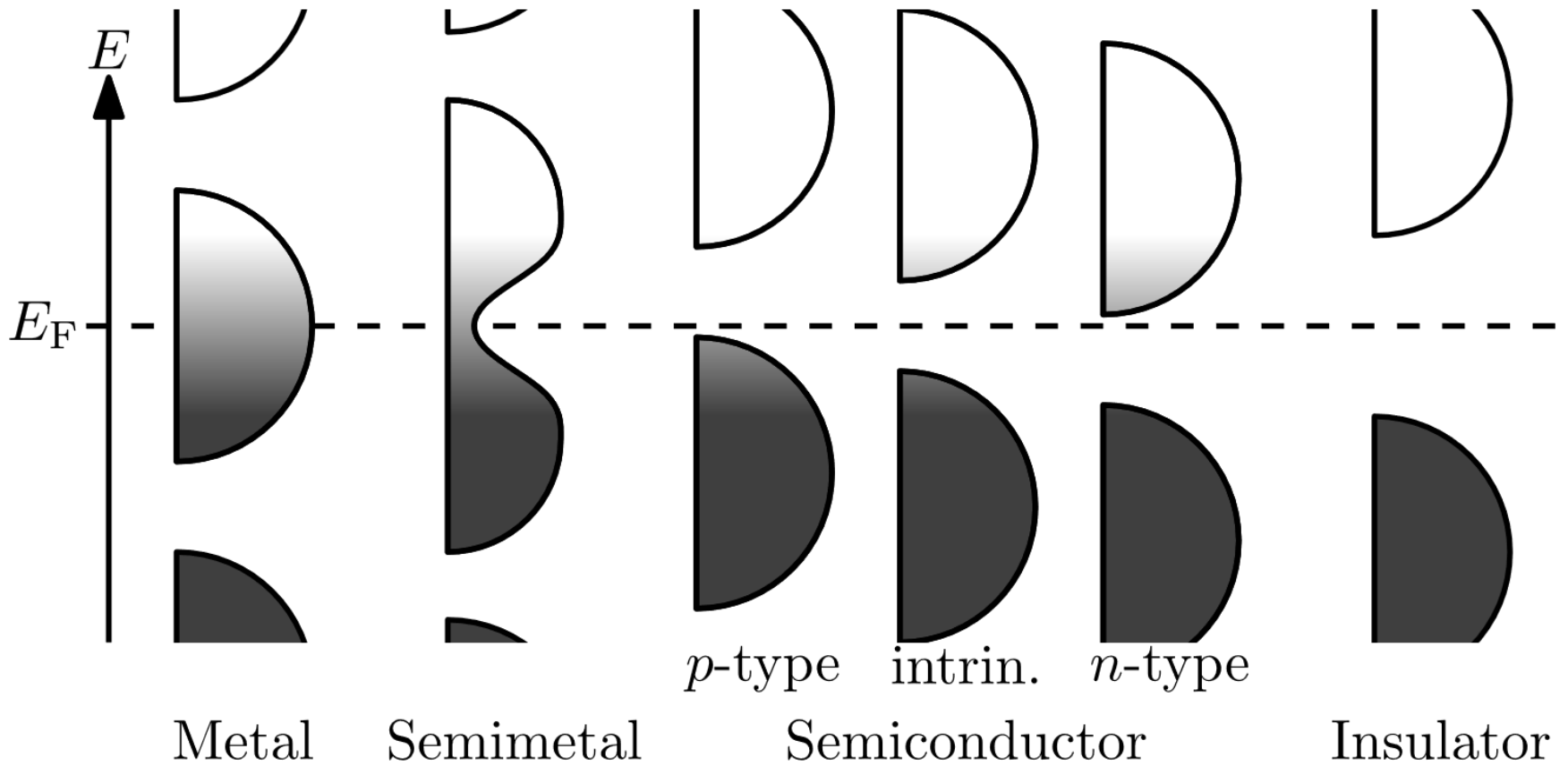

PERIODO	GRUPPO 1 IA		GRUPPO 2 IIA		GRUPPO IUPAC										GRUPPO 16 VIA		GRUPPO 17 VIIA		GRUPPO 18 VIIIA
	1	2	3	4	5	6	7	8	9	10	11	12	13	14	15	16	17	18	
1	1.0079 H IDROGENO																		2 4.0026 He ELIO
2	3 6.941 Li LITIO	4 9.0122 Be BERILLIO			5 10.811 B BORO								6 10.811 B BORO	6 12.011 C CARBONIO	7 14.007 N AZOTO	8 15.999 O OSSIGENO	9 18.998 F FLUORO	10 20.180 Ne NEO	
3	11 22.990 Na SODIO	12 24.305 Mg MAGNESIO											13 26.982 Al ALLUMINIO	14 28.086 Si SILICIO	15 30.974 P FOSFORO	16 32.065 S SOLFO	17 35.453 Cl CLORO	18 39.948 Ar ARGO	
4	19 39.098 K POTASSIO	20 40.078 Ca CALCIO	21 44.956 Sc SCANDIO	22 47.867 Ti TITANIO	23 50.942 V VANADIO	24 51.996 Cr CROMO	25 54.938 Mn MANGANESE	26 55.845 Fe FERRO	27 58.933 Co COBALTO	28 58.693 Ni NICHEL	29 63.546 Cu RAME	30 65.38 Zn ZINCO	31 69.723 Ga GALLIO	32 72.64 Ge GERMANIO	33 74.922 As ARSENICO	34 78.96 Se SELENIO	35 79.904 Br BROMO	36 83.798 Kr CRIPTO	
5	37 85.468 Rb RUBIDIO	38 87.62 Sr STRONZIO	39 88.906 Y ITTRIO	40 91.224 Zr ZIRCONIO	41 92.906 Nb NIOBIO	42 95.96 Mo MOLIBDENO	43 (98) Tc TECNETO	44 101.07 Ru RUTENIO	45 102.91 Rh RODIO	46 106.42 Pd PALLADIO	47 107.87 Ag ARGENTO	48 112.41 Cd CADMIO	49 114.82 In INDIO	50 118.71 Sn STAGNO	51 121.76 Sb ANTIMONIO	52 127.60 Te TELLURIO	53 126.90 I IODIO	54 131.29 Xe XENO	
6	55 132.91 Cs CESIO	56 137.33 Ba BARIO	57-71 La-Lu Lantanidi	72 178.49 Hf AFNIO	73 180.95 Ta TANTALIO	74 183.84 W WOLFRAMIO	75 186.21 Re RENI	76 190.23 Os OSMIO	77 192.22 Ir IRIDIO	78 195.08 Pt PLATINO	79 196.97 Au ORO	80 200.59 Hg MERCURIO	81 204.38 Tl TALLIO	82 207.2 Pb PIOMBO	83 208.98 Bi BISMUTO	84 (209) Po POLONIO	85 (210) At ASTATO	86 (222) Rn RADON	
7	87 (223) Fr FRANCIO	88 (226) Ra RADIO	89-103 Ac-Lr Attinidi	104 (267) Rf RUTHERFORDIO	105 (268) Db DUBNIO	106 (271) Sg SEABORGIO	107 (272) Bh BOHRIO	108 (277) Hs HASSIO	109 (276) Mt MEITNERIO	110 (281) Ds DARMSTADTIO	111 (280) Rg ROENTGENIO	112 (285) Cn COPERNICIO	113 (...) Uut UNUNTRIO	114 (287) Fl FLEROVIO	115 (...) Uup UNUNPENTIO	116 (291) Lv LIVERMORIO	117 (...) Uus UNUNSEPTIO	118 (...) Uuo UNUNOCTIO	

LANTANIDI

57 138.91 La LANTANIO	58 140.12 Ce CERIO	59 140.91 Pr PRASEODIMIO	60 144.24 Nd NEODIMIO	61 (145) Pm PROMETIO	62 150.36 Sm SAMARIO	63 151.96 Eu EUROPIO	64 157.25 Gd GADOLINIO	65 158.93 Tb TERBIO	66 162.50 Dy DISPROSIO	67 164.93 Ho OLMIO	68 167.26 Er ERBIO	69 168.93 Tm TULIO	70 173.05 Yb ITTERBIO	71 174.97 Lu LUTEZIO
------------------------------------	---------------------------------	---------------------------------------	------------------------------------	-----------------------------------	-----------------------------------	-----------------------------------	-------------------------------------	----------------------------------	-------------------------------------	---------------------------------	---------------------------------	---------------------------------	------------------------------------	-----------------------------------

ATTINIDI

89 (227) Ac ATTINIO	90 232.04 Th TORIO	91 231.04 Pa PROTOATTINIO	92 238.03 U URANIO	93 (237) Np NETTUNIO	94 (244) Pu PLUTONIO	95 (243) Am AMERICIO	96 (247) Cm CURIO	97 (247) Bk BERKELIO	98 (251) Cf CALIFORNIO	99 (252) Es EINSTEINIO	100 (257) Fm FERMIO	101 (258) Md MENDELEVIO	102 (259) No NOBELIO	103 (262) Lr LAWRENTIO
----------------------------------	---------------------------------	--	---------------------------------	-----------------------------------	-----------------------------------	-----------------------------------	--------------------------------	-----------------------------------	-------------------------------------	-------------------------------------	----------------------------------	--------------------------------------	-----------------------------------	-------------------------------------

Copyright © 2012 Eni Generali©

(1) Pure Appl. Chem., 81, No. 11, 2131-2156 (2009)
Le masse atomiche relative sono espresse con cinque cifre significative. L'elemento non ha alcuni nuclidi stabili e un valore tra parentesi, e.g. [209], indica il numero totale dell'isotopo lungo-vivo dell'elemento. Tuttavia, tre elementi (Th, Pa ed U) hanno una composizione isotopica terrestre caratteristica e così loro massa atomica data.



Semiconduttore intrinseco

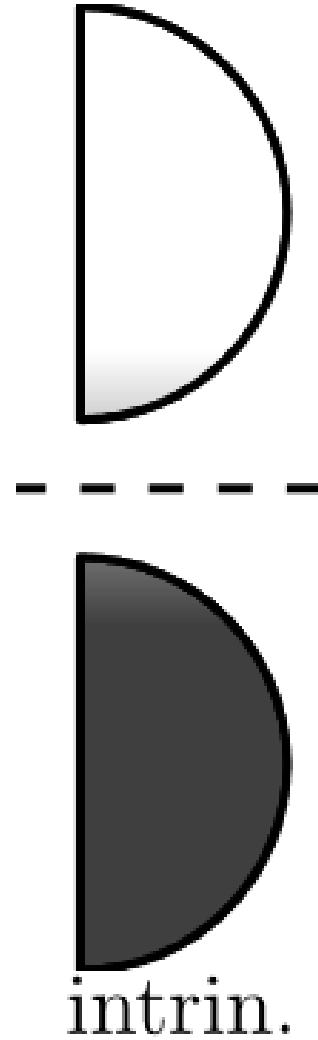
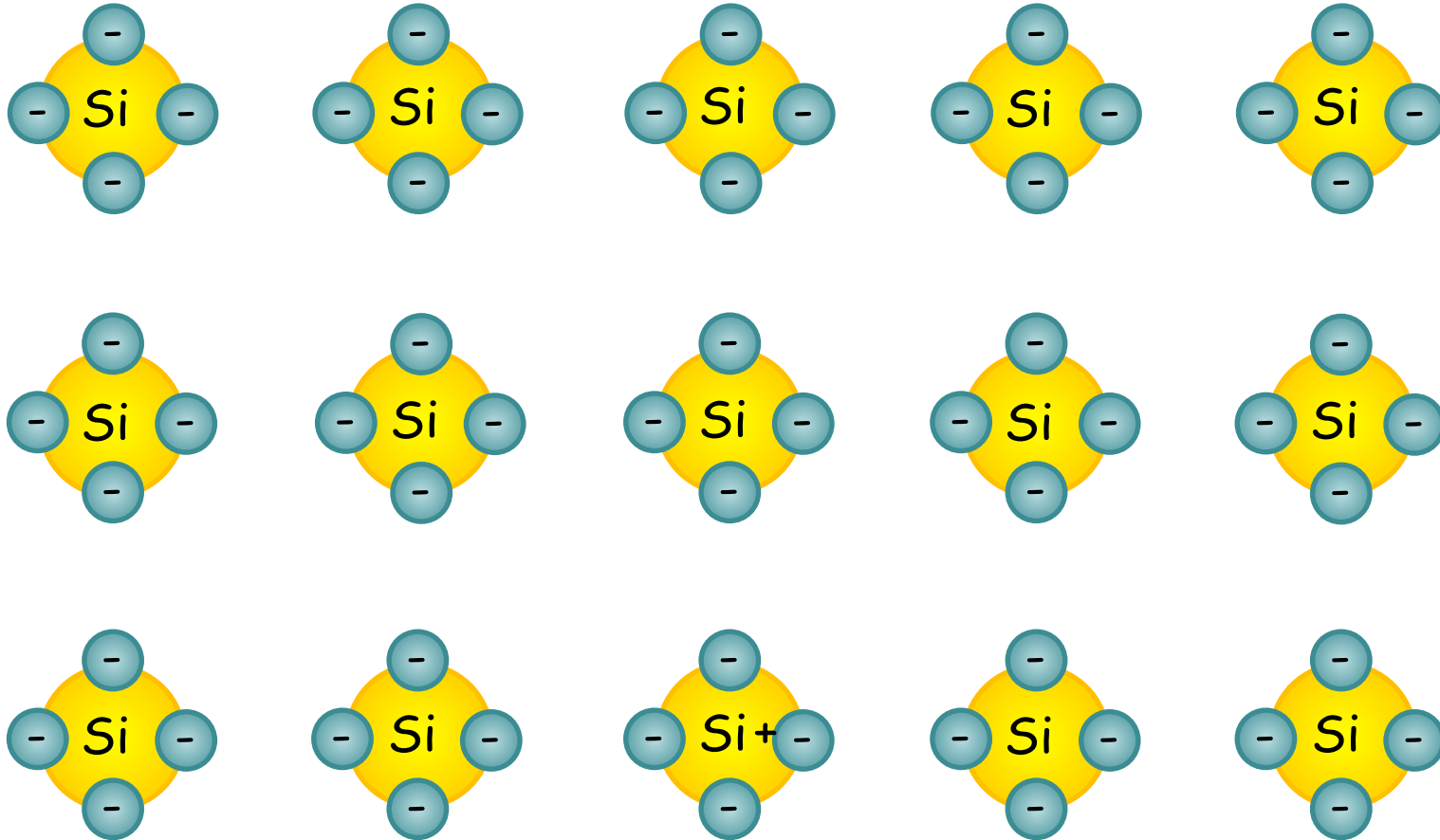



Semiconduttore tipo n

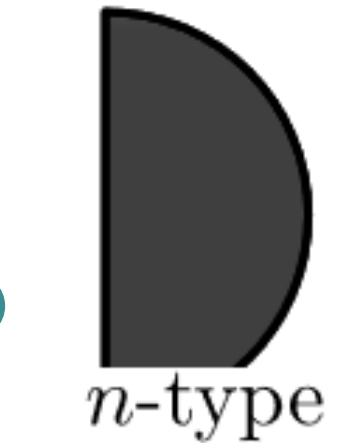
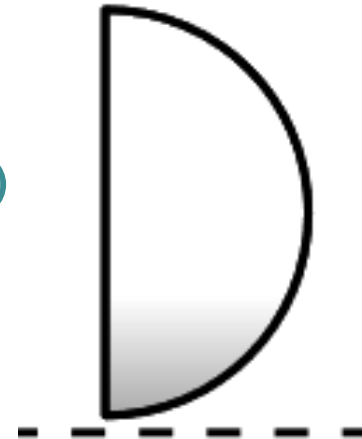
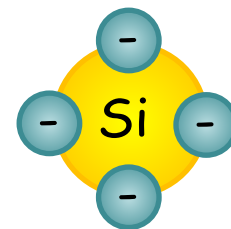
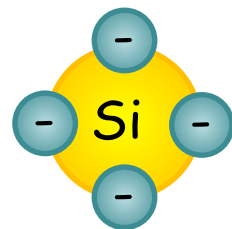
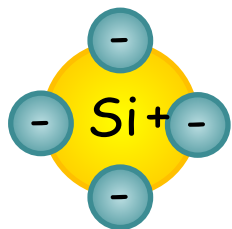
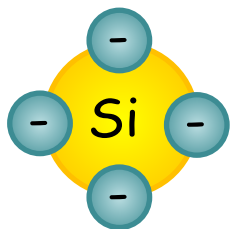
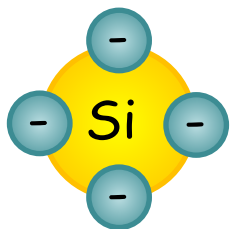
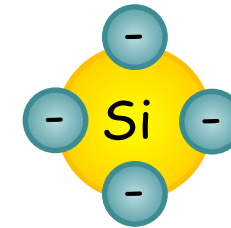
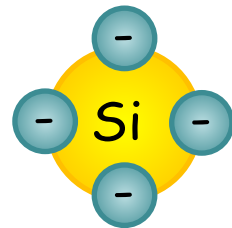
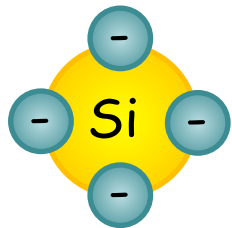
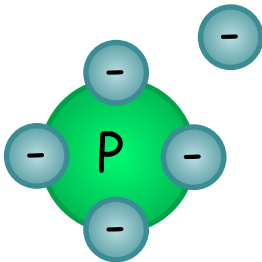
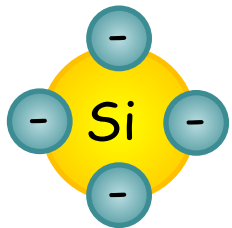
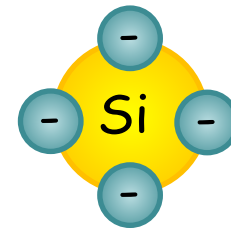
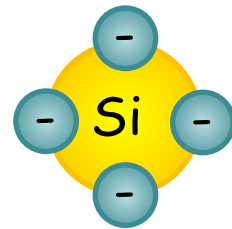
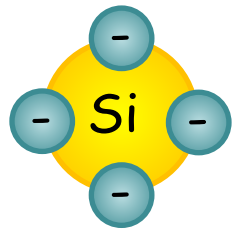
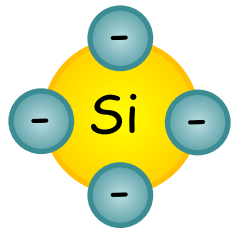
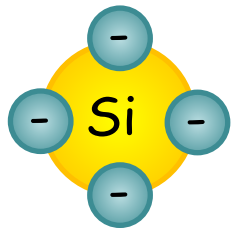

n-type



Semiconduttore tipo p

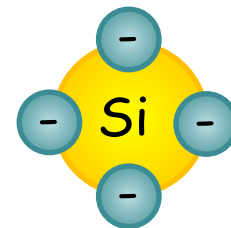
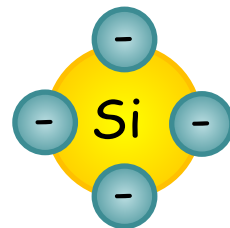
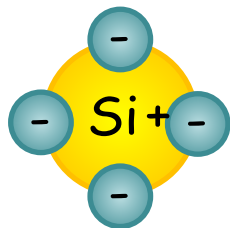
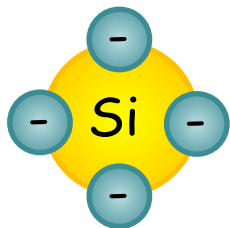
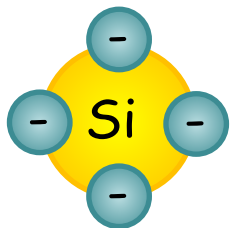
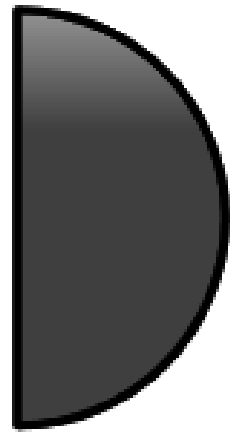
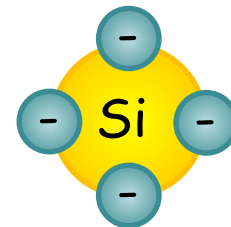
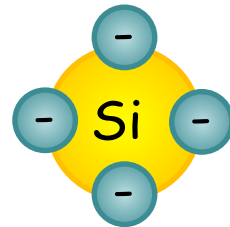
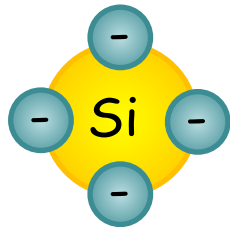
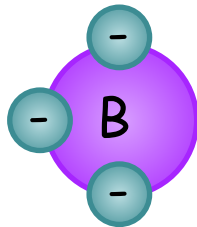
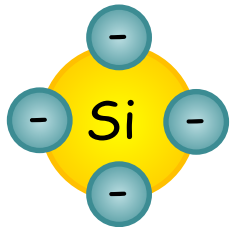
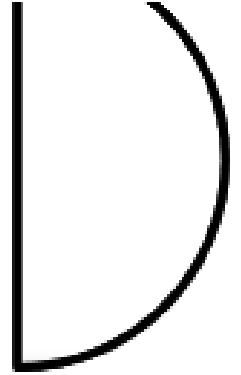
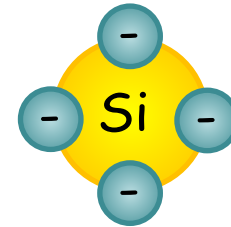
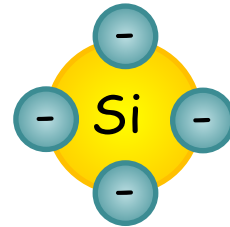
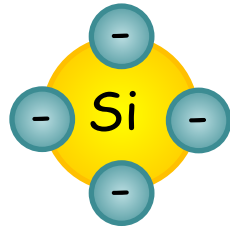
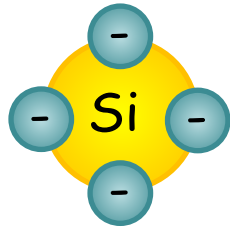
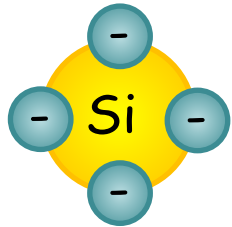

p-type

tavola di Mendeleev

TAVOLA PERIODICA DEGLI ELEMENTI

<http://www.periodni.com/it/>



PERIODO	GRUPPO 1 IA		GRUPPO 2 IIA		GRUPPO IUPAC										GRUPPO 16 VIA		GRUPPO 17 VIIA		GRUPPO 18 VIIIA	
1	1	2											13	14	15	16	17	18		
1	1.0079 H IDROGENO																		4.0026 He ELIO	
2	3	4											5	6	7	8	9	10		
2	6.941 Li LITIO	9.0122 Be BERILLIO											10.811 B BORO	12.011 C CARBONIO	14.007 N AZOTO	15.999 O OSSIGENO	18.998 F FLUORO	20.180 Ne NEO		
3	11	12											13	14	15	16	17	18		
3	22.990 Na SODIO	24.305 Mg MAGNESIO											26.982 Al ALLUMINIO	28.086 Si SILICIO	30.974 P FOSFORO	32.065 S SOLFO	35.453 Cl CLORO	39.948 Ar ARGO		
4	19	20	21	22	23	24	25	26	27	28	29	30	31	32	33	34	35	36		
4	39.098 K POTASSIO	40.078 Ca CALCIO	44.956 Sc SCANDIO	47.867 Ti TITANIO	50.942 V VANADIO	51.996 Cr CROMO	54.938 Mn MANGANESE	55.845 Fe FERRO	58.933 Co COBALTO	58.693 Ni NICHEL	63.546 Cu RAME	65.38 Zn ZINCO	69.723 Ga GALLIO	72.64 Ge GERMANIO	74.922 As ARSENICO	78.96 Se SELENIO	79.904 Br BROMO	83.798 Kr CRIPTO		
5	37	38	39	40	41	42	43	44	45	46	47	48	49	50	51	52	53	54		
5	85.468 Rb RUBIDIO	87.62 Sr STRONZIO	88.906 Y ITTRIO	91.224 Zr ZIRCONIO	92.906 Nb NIOBIO	95.96 Mo MOLIBDENO	(98) Tc TECNETO	101.07 Ru RUTENIO	102.91 Rh RODIO	106.42 Pd PALLADIO	107.87 Ag ARGENTO	112.41 Cd CADMIO	114.82 In INDIO	118.71 Sn STAGNO	121.76 Sb ANTIMONIO	127.60 Te TELLURIO	126.90 I IODIO	131.29 Xe XENO		
6	55	56	57-71		72	73	74	75	76	77	78	79	80	81	82	83	84	85	86	
6	132.91 Cs CESIO	137.33 Ba BARIO	Lantanidi		178.49 Hf AFNIO	180.95 Ta TANTALIO	183.84 W WOLFRAMIO	186.21 Re RENI	190.23 Os OSMIO	192.22 Ir IRIDIO	195.08 Pt PLATINO	196.97 Au ORO	200.59 Hg MERCURIO	204.38 Tl TALLIO	207.2 Pb PIOMBO	208.98 Bi BISMUTO	(209) Po POLONIO	(210) At ASTATO	(222) Rn RADON	
7	87	88	89-103		104	105	106	107	108	109	110	111	112	113	114	115	116	117	118	
7	(223) Fr FRANCIO	(226) Ra RADIO	Attinidi		(267) Rf RUTHERFORDIO	(268) Db DUBNIO	(271) Sg SEABORGIO	(272) Bh BOHRIO	(277) Hs HASSIO	(276) Mt MEITNERIO	(281) Ds DARMSTADTIO	(280) Rg ROENTGENIO	(285) Cn COPERNICIO	(...) Uut UNUNTRIO	(287) Fl FLEROVIO	(...) Uup UNUNPENTIO	(291) Lv LIVERMORIO	(...) Uus UNUNSEPTIO	(...) Uuo UNUNOCTIO	

LANTANIDI

57	58	59	60	61	62	63	64	65	66	67	68	69	70	71
138.91 La LANTANIO	140.12 Ce CERIO	140.91 Pr PRASEODIMIO	144.24 Nd NEODIMIO	(145) Pm PROMETIO	150.36 Sm SAMARIO	151.96 Eu EUROPIO	157.25 Gd GADOLINIO	158.93 Tb TERBIO	162.50 Dy DISPROSIO	164.93 Ho OLMIO	167.26 Er ERBIO	168.93 Tm TULIO	173.05 Yb ITTERBIO	174.97 Lu LUTEZIO

ATTINIDI

89	90	91	92	93	94	95	96	97	98	99	100	101	102	103
(227) Ac ATTINIO	232.04 Th TORIO	231.04 Pa PROTOATTINIO	238.03 U URANIO	(237) Np NETTUNIO	(244) Pu PLUTONIO	(243) Am AMERICIO	(247) Cm CURIO	(247) Bk BERKELIO	(251) Cf CALIFORNIO	(252) Es EINSTEINIO	(257) Fm FERMIO	(258) Md MENDELEVIO	(259) No NOBELIO	(262) Lr LAWRENTIO

Copyright © 2012 Eni Generali©

(1) Pure Appl. Chem., 81, No. 11, 2131-2156 (2009)

Le masse atomiche relative sono espresse con cinque cifre significative. L'elemento non ha alcuni nuclidi stabili e un valore tra parentesi, e.g. [209], indica il numero totale dell'isotopo lungo-vivo dell'elemento. Tuttavia, tre elementi (Th, Pa ed U) hanno una composizione isotopica terrestre caratteristica e così loro massa atomica data.

tavola di Mendeleev

TAVOLA PERIODICA DEGLI ELEMENTI

<http://www.periodni.com/it/>



PERIODO	GRUPPO																		18
	1	2	GRUPPO IUPAC										13	14	15	16	17	18	
	IA	IIA											IIIA	IVA	VA	VIA	VIIA	VIIIA	
1	1.0079 H IDROGENO																		2.0039 He ELIO
2	6.941 Li LITIO	9.0122 Be BERILLIO											10.811 B BORO	12.011 C CARBONIO	14.007 N AZOTO	15.999 O OSSIGENO	18.998 F FLUORO	20.180 Ne NEO	
3	22.990 Na SODIO	24.305 Mg MAGNESIO											26.982 Al ALLUMINIO	28.086 Si SILICIO	30.974 P FOSFORO	32.065 S SOLFO	35.453 Cl CLORO	39.948 Ar ARGO	
4	39.098 K POTASSIO	40.078 Ca CALCIO	44.956 Sc SCANDIO	47.867 Ti TITANIO	50.942 V VANADIO	51.996 Cr CROMO	54.938 Mn MANGANESE	58.933 Fe FERRO	58.933 Co COBALTO	63.546 Ni NICHEL	65.38 Cu RAME	65.38 Zn ZINCO	69.723 Ga GALLIO	72.64 Ge GERMANIO	74.922 As ARSENICO	78.96 Se SELENIO	79.904 Br BROMO	83.798 Kr CRIPTO	
5	85.468 Rb RUBIDIO	87.62 Sr STRONZIO	88.906 Y ITTRIO	91.224 Zr ZIRCONIO	92.906 Nb NIOBIO	95.96 Mo MOLIBDENO	95.96 Tc TECNIZIO	Carburo di Silicio SiC					101.07 Tl TALLIO	106.3 Pb PIOMBO	106.3 Bi BISMUTO	106.3 Po POLONIO	106.3 At ASTATO	106.3 Rn RADON	
6	132.91 Cs CESIO	137.33 Ba BARIO	137.33 La-Lu Lantanidi	178.49 Hf AFNIO	180.95 Ta TANTALIO	183.84 W WOLFRAMIO	186.21 Re RENIUM	190.23 Os OSMIO	192.22 Ir IRIDIO	195.08 Pt PLATINO	196.97 Au ORO	200.59 Hg MERCURIO	204.38 Tl TALLIO	207.2 Pb PIOMBO	208.98 Bi BISMUTO	(209) Po POLONIO	(210) At ASTATO	(222) Rn RADON	
7	(223) Fr FRANCIO	(226) Ra RADIO	(227) Ac-Lr Attinidi	(267) Rf RUTHERFORDIO	(268) Db DUBNIO	(271) Sg SEABORGIO	(272) Bh BOHRIO	(277) Hs HASSIO	(276) Mt MEITNERIO	(281) Ds DARMSTADTIO	(280) Rg ROENTGENIO	(285) Cn COPERNICIO	(...) Uut UNUNTRO	(287) Fl FLEROVIO	(...) Uup UNUNPENTIO	(291) Lv LIVERMORIO	(...) Uus UNUNSEPTIO	(...) Uuo UNUNOCTIO	

LANTANIDI

57 138.91 La LANTANIO	58 140.12 Ce CERIO	59 140.91 Pr PRASEODIMIO	60 144.24 Nd NEODIMIO	61 (145) Pm PROMETIO	62 150.36 Sm SAMARIO	63 151.96 Eu EUROPIO	64 157.25 Gd GADOLINIO	65 158.93 Tb TERBIO	66 162.50 Dy DISPROSIO	67 164.93 Ho OLMIO	68 167.26 Er ERBIO	69 168.93 Tm TULIO	70 173.05 Yb ITTERBIO	71 174.97 Lu LUTEZIO
------------------------------------	---------------------------------	---------------------------------------	------------------------------------	-----------------------------------	-----------------------------------	-----------------------------------	-------------------------------------	----------------------------------	-------------------------------------	---------------------------------	---------------------------------	---------------------------------	------------------------------------	-----------------------------------

ATTINIDI

89 (227) Ac ATTINIO	90 232.04 Th TORIO	91 231.04 Pa PROTOATTINIO	92 238.03 U URANIO	93 (237) Np NETTUNIO	94 (244) Pu PLUTONIO	95 (243) Am AMERICIO	96 (247) Cm CURIO	97 (247) Bk BERKELIO	98 (251) Cf CALIFORNIO	99 (252) Es EINSTEINIO	100 (257) Fm FERMIO	101 (258) Md MENDELEVIO	102 (259) No NOBELIO	103 (262) Lr LAWRENTIO
----------------------------------	---------------------------------	--	---------------------------------	-----------------------------------	-----------------------------------	-----------------------------------	--------------------------------	-----------------------------------	-------------------------------------	-------------------------------------	----------------------------------	--------------------------------------	-----------------------------------	-------------------------------------

Copyright © 2012 Eni Generali©

(1) Pure Appl. Chem., 81, No. 11, 2131-2156 (2009)

Le masse atomiche relative sono espresse con cinque cifre significative. L'elemento non ha alcuni nuclidi stabili e un valore tra parentesi, e.g. [209], indica il numero totale dell'isotopo lungo-vivo dell'elemento. Tuttavia, tre elementi (Th, Pa ed U) hanno una composizione isotopica terrestre caratteristica e così loro massa atomica data.

tavola di Mendeleev

TAVOLA PERIODICA DEGLI ELEMENTI

<http://www.periodni.com/it/>



PERIODO	GRUPPO 1 IA		GRUPPO 2 IIA		GRUPPO IUPAC										GRUPPO 16 VIA		GRUPPO 17 VIIA		GRUPPO 18 VIIIA																	
1	1	1.0079																	18																	
2	3	6.941	4	9.0122															10																	
3	11	22.990	12	24.305															18																	
4	19	39.098	20	40.078	21	44.956	22	47.867	23	50.942	24	51.996	25	54.938	26	55.845	27	58.933	28	58.693	29	63.546	30	65.38	31	69.723	32	72.64	33	74.922	34	78.96	35	79.904	36	83.798
5	37	85.468	38	87.62	39	88.906	40	91.224	41	92.906	42	95.96	43		44		45		46		47		48		49		50		51		52		53		54	81.29
6	55	132.91	56	137.33	57-71 Lantanidi		72	178.49	73	180.95	74	183.84	75	186.21	76	190.23	77	192.22	78	195.08	79	196.97	80	200.59	81	204.38	82	207.2	83	208.98	84	(209)	85	(210)	86	(222)
7	87	(223)	88	(226)	89-103 Attinidi		104	(267)	105	(268)	106	(271)	107	(272)	108	(277)	109	(276)	110	(281)	111	(280)	112	(285)	113	(...)	114	(287)	115	(...)	116	(291)	117	(...)	118	(...)

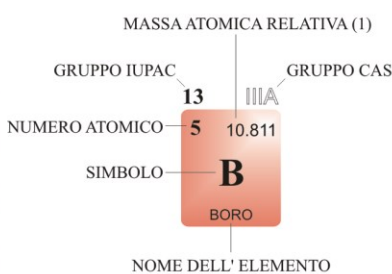

STATO DI AGGREGAZIONE A 25 °C

Ne - gas Fe - solido
Hg - liquido Tc - artificiali

Germaniuro di Silicio SiC

LANTANIDI																													
57	138.91	58	140.12	59	140.91	60	144.24	61	(145)	62	150.36	63	151.96	64	157.25	65	158.93	66	162.50	67	164.93	68	167.26	69	168.93	70	173.05	71	174.97
La	Ce	Pr	Nd	Pm	Sm	Eu	Gd	Tb	Dy	Ho	Er	Tm	Yb	Lu															
LANTANIO	CERIO	PRASEODIMIO	NEODIMIO	PROMETIO	SAMARIO	EUROPIO	GADOLINIO	TERBIO	DISPROSIO	OLMIO	ERBIO	TULIO	ITTERBIO	LUTEZIO															
ATTINIDI																													
89	(227)	90	232.04	91	231.04	92	238.03	93	(237)	94	(244)	95	(243)	96	(247)	97	(247)	98	(251)	99	(252)	100	(257)	101	(258)	102	(259)	103	(262)
Ac	Th	Pa	U	Np	Pu	Am	Cm	Bk	Cf	Es	Fm	Md	No	Lr															
ATTINIO	TORIO	PROTOATTINIO	URANIO	NETTUNIO	PLUTONIO	AMERICIO	CURIO	BERKELIO	CALIFORNIO	EINSTEINIO	FERMIO	MENDELEVIO	NOBELIO	LAWRENTIO															

Copyright © 2012 Eni Generali©

(1) Pure Appl. Chem., 81, No. 11, 2131-2156 (2009)
 Le masse atomiche relative sono espresse con cinque cifre significative. L'elemento non ha alcuni nuclidi stabili e un valore tra parentesi, e.g. [209], indica il numero totale dell'isotopo lungo-vivo dell'elemento. Tuttavia, tre elementi (Th, Pa ed U) hanno una composizione isotopica terrestre caratteristica e così loro massa atomica data.

tavola di Mendeleev

TAVOLA PERIODICA DEGLI ELEMENTI

<http://www.periodic-table.com/it/>

PERIODO	GRUPPO		GRUPPO IUPAC																GRUPPO CAS	
	1	2	3	4	5	6	7	8	9	10	11	12	13	14	15	16	17	18		
	IA	IIA	IIIB	IVB	VB	VIB	VII B	VIII B	VIII B	VIII B	IB	IIB	IIIA	IVA	VA	VIA	VIIA	VIIIA		
1	1.0079 H IDROGENO																		2 4.0026 He ELIO	
2	3 6.941 Li LITIO	4 9.0122 Be BERILLIO											5 10.811 B BORO	6 12.011 C CARBONIO	7 14.007 N AZOTO	8 15.999 O OSSIGENO	9 18.998 F FLUORO	10 20.180 Ne NEO		
3	11 22.990 Na SODIO	12 24.305 Mg MAGNESIO											13 26.982 Al ALLUMINIO	14 28.086 Si SILICIO	15 30.974 P FOSFORO	16 32.065 S SOLFO	17 35.453 Cl CLORO	18 39.948 Ar ARGO		
4	19 39.098 K POTASSIO	20 40.078 Ca CALCIO	21 44.956 Sc SCANDIO	22 47.867 Ti TITANIO	23 50.942 V VANADIO	24 51.996 Cr CROMO	25 54.938 Mn MANGANESE	26 55.845 Fe FERRO	27 58.933 Co COBALTO	28 58.693 Ni NICHEL	29 63.546 Cu RAME	30 65.38 Zn ZINCO	31 69.723 Ga GALLIO	32 72.64 Ge GERMANIO	33 74.922 As ARSENICO	34 78.96 Se SELENIO	35 79.904 Br BROMO	36 83.798 Kr CRIPTO		
5	37 85.468 Rb RUBIDIO	38 87.62 Sr STRONZIO	39 88.906 Y ITTRIO	40 91.224 Zr ZIRCONIO	41 92.906 Nb NIOBIO	42 95.96 Mo MOLIBDENO	43 (98) Tc TECNETO	44 101.07 Ru RUTENIO	45 102.91 Rh RHODIO	46 106.42 Pd PALADIO	47 107.87 Ag ARGENTO	48 112.41 Cd CADMIO	49 114.82 In INDIO	50 118.71 Sn STAGNO	51 121.76 Sb ANTIMONIO	52 127.60 Te TELURO	53 126.90 I IODIO	54 131.29 Xe XENONO		
6	55 132.91 Cs CESIO	56 137.33 Ba BARIO	57-71 La-Lu Lantanidi	72 178.49 Hf HAFNIO	73 180.95 Ta TANTALIO	74 183.84 W WOLFRAMIO	75 186.21 Re RENEO	76 187 Os OSMIO	77 188.91 Ir IRIDIO	78 193.22 Pt PLATINO	79 197.04 Au ORO	80 200.59 Hg MERCURIO	81 204.39 Tl TALLIO	82 208.98 Pb PIOMBO	83 208.98 Bi BISMUTO	84 209 Po POLONIO	85 209 At ASTATO	86 210 Rn RADON		
7	87 (223) Fr FRANCIO	88 (226) Ra RADIO	89-103 Ac-Lr Attinidi	104 (267) Rf RUTHERFORDIO	105 (268) Db DUBNIO	106 (271) Sg SEABORGIO	107 (272) Bh BOHRIO	108 (277) Hs HASSIO	109 (276) Mt MEITNERIO	110 (281) Ds DARMSTADTIO	111 (280) Rg ROENTGENIO	112 (285) Cn COPERNICIO	113 (...) Uut UNUNTRIO	114 (287) Fl FLEROVIO	115 (...) Uup UNUNPENTIO	116 (291) Lv LIVERMORIO	117 (...) Uus UNUNSEPTIO	118 (...) Uuo UNUNOCTIO		

Arseniuro di Alluminio AlAs

LANTANIDI

57 138.91 La LANTANIO	58 140.12 Ce CERIO	59 140.91 Pr PRASEODIMIO	60 144.24 Nd NEODIMIO	61 (145) Pm PROMETIO	62 150.36 Sm SAMARIO	63 151.96 Eu EUROPIO	64 157.25 Gd GADOLINIO	65 158.93 Tb TERBIO	66 162.50 Dy DISPROSIO	67 164.93 Ho OLMIO	68 167.26 Er ERBIO	69 168.93 Tm TULIO	70 173.05 Yb ITTERBIO	71 174.97 Lu LUTEZIO
------------------------------------	---------------------------------	---------------------------------------	------------------------------------	-----------------------------------	-----------------------------------	-----------------------------------	-------------------------------------	----------------------------------	-------------------------------------	---------------------------------	---------------------------------	---------------------------------	------------------------------------	-----------------------------------

ATTINIDI

89 (227) Ac ATTINIO	90 232.04 Th TORIO	91 231.04 Pa PROTOATTINIO	92 238.03 U URANIO	93 (237) Np NETTUNIO	94 (244) Pu PLUTONIO	95 (243) Am AMERICIO	96 (247) Cm CURIO	97 (247) Bk BERKELIO	98 (251) Cf CALIFORNIO	99 (252) Es EINSTEINIO	100 (257) Fm FERMIO	101 (258) Md MENDELEVIO	102 (259) No NOBELIO	103 (262) Lr LAWRENTIO
----------------------------------	---------------------------------	--	---------------------------------	-----------------------------------	-----------------------------------	-----------------------------------	--------------------------------	-----------------------------------	-------------------------------------	-------------------------------------	----------------------------------	--------------------------------------	-----------------------------------	-------------------------------------

Copyright © 2012 Eni Generalic

(1) Pure Appl. Chem., 81, No. 11, 2131-2156 (2009)
Le masse atomiche relative sono espresse con cinque cifre significative. L'elemento non ha alcuni nuclidi stabili e un valore tra parentesi, e.g. [209], indica il numero totale dell'isotopo lungo-vivo dell'elemento. Tuttavia, tre elementi (Th, Pa ed U) hanno una composizione isotopica terrestre caratteristica e così loro massa atomica data.

tavola di Mendeleev

TAVOLA PERIODICA DEGLI ELEMENTI

<http://www.periodic-table.com/it/>

PERIODO	GRUPPO		GRUPPO IUPAC																GRUPPO CAS	
	1	2	3	4	5	6	7	8	9	10	11	12	13	14	15	16	17	18		
	IA	IIA	IIIB	IVB	VB	VIB	VII B	VIII B	VIII B	VIII B	IB	IIB	IIIA	IVA	VA	VIA	VIIA	VIIIA		
1	1.0079 H IDROGENO																		2 4.0026 He ELIO	
2	3 6.941 Li LITIO	4 9.0122 Be BERILLIO											5 10.811 B BORO	6 12.011 C CARBONIO	7 14.007 N AZOTO	8 15.999 O OSSIGENO	9 18.998 F FLUORO	10 20.180 Ne NEO		
3	11 22.990 Na SODIO	12 24.305 Mg MAGNESIO											13 26.982 Al ALLUMINIO	14 28.086 Si SILICIO	15 30.974 P FOSFORO	16 32.065 S SOLFO	17 35.453 Cl CLORO	18 39.948 Ar ARGO		
4	19 39.098 K POTASSIO	20 40.078 Ca CALCIO	21 44.956 Sc SCANDIO	22 47.867 Ti TITANIO	23 50.942 V VANADIO	24 51.996 Cr CROMO	25 54.938 Mn MANGANESE	26 55.845 Fe FERRO	27 58.933 Co COBALTO	28 58.693 Ni NICHEL	29 63.546 Cu RAME	30 65.38 Zn ZINCO	31 69.723 Ga GALLIO	32 72.64 Ge GERMANIO	33 74.922 As ARSENICO	34 78.96 Se SELENIO	35 79.904 Br BROMO	36 83.798 Kr CRIPTO		
5	37 85.468 Rb RUBIDIO	38 87.62 Sr STRONZIO	39 88.906 Y ITTRIO	40 91.224 Zr ZIRCONIO	41 92.906 Nb NIOBIO	42 95.96 Mo MOLIBDENO	43 (98) Tc TECNETO	44 101.07 Ru RUTENIO	45 102.91 Rh RHODIO	46 106.42 Pd PALADIO	47 107.87 Au ORO	48 112.41 Hg MERCURIO	49 114.82 Tl TALLIO	50 118.71 Pb PIOMBO	51 121.76 Bi BISMUTTO	52 127.60 Po POLONIO	53 126.90 At ASTATINIO	54 131.29 Po POLONIO		
6	55 132.91 Cs CESIO	56 137.33 Ba BARIO	57-71 La-Lu Lantanidi	72 178.49 Hf AFNIO	73 180.95 Ta TANTALIO	74 183.84 W WOLFRAMIO	75 186.21 Re RENIO	76 187 Os OSMIO	77 188.91 Ir IRIDIO	78 188.85 Pt PLATINO	79 197.04 Au ORO	80 200.59 Hg MERCURIO	81 204.38 Tl TALLIO	82 208.98 Pb PIOMBO	83 208.98 Bi BISMUTTO	84 208.98 Po POLONIO	85 208.98 At ASTATINIO	86 208.98 Rn RADON		
7	87 (223) Fr FRANCIO	88 (226) Ra RADIO	89-103 Ac-Lr Attinidi	104 (267) Rf RUTERFORDIO	105 (268) Db DUBNIO	106 (271) Sg SEABORGIO	107 (272) Bh BOHRIO	108 (277) Hs HASSIO	109 (277) Mt MEITNERIO	110 (277) Ds DARMSTADTIO	111 (277) Rg ROENTGENIO	112 (277) Cn COPERNICIO	113 (277) Nh NUNTRIO	114 (277) Fl FLEROVIO	115 (277) Mc MUNDEPTIO	116 (277) Lv LIVERMORIO	117 (277) Ts TUNSEPTIO	118 (277) Og OUNOCTIO		

Arseniuro di Gallio e Alluminio
lega AlAs e GaAs
 $Al_xGa_{1-x}As$

LANTANIDI

57 138.91 La LANTANIO	58 140.12 Ce CERIO	59 140.91 Pr PRASEODIMIO	60 144.24 Nd NEODIMIO	61 (145) Pm PROMETIO	62 150.36 Sm SAMARIO	63 151.96 Eu EUROPIO	64 157.25 Gd GADOLINIO	65 158.93 Tb TERBIO	66 162.50 Dy DISPROSIO	67 164.93 Ho OLMIO	68 167.26 Er ERBIO	69 168.93 Tm TULIO	70 173.05 Yb ITTERBIO	71 174.97 Lu LUTEZIO
------------------------------------	---------------------------------	---------------------------------------	------------------------------------	-----------------------------------	-----------------------------------	-----------------------------------	-------------------------------------	----------------------------------	-------------------------------------	---------------------------------	---------------------------------	---------------------------------	------------------------------------	-----------------------------------

ATTINIDI

89 (227) Ac ATTINIO	90 232.04 Th TORIO	91 231.04 Pa PROTOATTINIO	92 238.03 U URANIO	93 (237) Np NETTUNIO	94 (244) Pu PLUTONIO	95 (243) Am AMERICIO	96 (247) Cm CURIO	97 (247) Bk BERKELIO	98 (251) Cf CALIFORNIO	99 (252) Es EINSTEINIO	100 (257) Fm FERMIO	101 (258) Md MENDELEVIO	102 (259) No NOBELIO	103 (262) Lr LAWRENTIO
----------------------------------	---------------------------------	--	---------------------------------	-----------------------------------	-----------------------------------	-----------------------------------	--------------------------------	-----------------------------------	-------------------------------------	-------------------------------------	----------------------------------	--------------------------------------	-----------------------------------	-------------------------------------

Copyright © 2012 Eni Generali©

(1) Pure Appl. Chem., 81, No. 11, 2131-2156 (2009)
Le masse atomiche relative sono espresse con cinque cifre significative. L'elemento non ha alcuni nuclidi stabili e un valore tra parentesi, e.g. [209], indica il numero totale dell'isotopo lungo-vivo dell'elemento. Tuttavia, tre elementi (Th, Pa ed U) hanno una composizione isotopica terrestre caratteristica e così loro massa atomica data.

tavola di Mendeleev

TAVOLA PERIODICA DEGLI ELEMENTI

<http://www.periodic-table.com/it/>

PERIODO	GRUPPO																		18
	1	2	GRUPPO IUPAC										13	14	15	16	17	VIIIA	
	IA	IIA											IIIA	IVA	VA	VIA	VIIA	VIIIA	
1	1.0079 H IDROGENO																		2 4.0026 He ELIO
2	3 6.941 Li LITIO	4 9.0122 Be BERILLIO											5 10.811 B BORO	6 12.01 C CARBONIO	7 14.007 N AZOTO	8 15.999 O OSSIGENO	9 18.998 F FLUORO	10 20.180 Ne NEO	
3	11 22.990 Na SODIO	12 24.305 Mg MAGNESIO											13 26.982 Al ALLUMINIO	14 28.086 Si SILICIO	15 30.974 P FOSFORO	16 32.065 S SOLFO	17 35.453 Cl CLORO	18 39.948 Ar ARGO	
4	19 39.098 K POTASSIO	20 40.078 Ca CALCIO	21 44.956 Sc SCANDIO	22 47.867 Ti TITANIO	23 50.942 V VANADIO	24 51.996 Cr CROMO	25 54.938 Mn MANGANESE	26 55.845 Fe FERRO	27 58.933 Co COBALTO	28 58.693 Ni NICHEL	29 63.546 Cu RAME	30 65.38 Zn ZINCO	31 69.723 Ga GALLIO	32 72.64 Ge GERMANIO	33 74.922 As ARSENICO	34 78.96 Se SELENIO	35 79.904 Br BROMO	36 83.798 Kr CRIPTO	
5	37 85.468 Rb RUBIDIO	38 87.62 Sr STRONZIO	39 88.906 Y ITTRIO	40 91.224 Zr ZIRCONIO	41 92.906 Nb NIOBIO	42 95.96 Mo MOLIBDENO	43 (98) Tc TECNETO	44 101.07 Ru RUBIDIO	45 102.91 Rh RUBIDIO	46 106.42 Pd RUBIDIO	47 107.87 Au ORO	48 112.41 Hg MERCURIO	49 114.82 Tl TALLIO	50 118.71 Pb PIOMBO	51 121.76 Bi BISMUTO	52 127.60 Po POLONIO	53 126.90 At ASTATO	54 131.29 Rn RADON	
6	55 132.91 Cs CESIO	56 137.33 Ba BARIO	57-71 La-Lu Lantanidi	72 178.49 Hf AFNIO	73 180.95 Ta TANTALIO	74 183.84 W WOLFRAMIO	75 186.21 Re RENIUM	76 187 Os OSMIO	77 188.91 Ir IRIDIO	78 193.22 Pt PLATINO	79 197.04 Au ORO	80 200.59 Hg MERCURIO	81 204.38 Tl TALLIO	82 208.98 Pb PIOMBO	83 208.98 Bi BISMUTO	84 209 Po POLONIO	85 209 At ASTATO	86 222 Rn RADON	
7	87 (223) Fr FRANCIO	88 (226) Ra RADIO	89-103 Ac-Lr Attinidi	104 (267) Rf RUTHERFORDIO	105 (268) Db DUBNIO	106 (271) Sg SEABORGIO	107 (272) Bh BOHRIO	108 (277) Hs HASSIO	109 (276) Mt MEITNERIO	110 (281) Ds DARMSTADTIO	111 (280) Rg ROENTGENIO	112 (285) Cn COPERNICIO	113 (...) Uut UNUNTRIO	114 (287) Fl FLEROVIO	115 (...) Uup UNUNPENTIO	116 (291) Lv LIVERMORIO	117 (...) Uus UNUNSEPTIO	118 (...) Uuo UNUNOCTIO	

Nitruro di Boro BN

LANTANIDI

57 138.91 La LANTANIO	58 140.12 Ce CERIO	59 140.91 Pr PRASEODIMIO	60 144.24 Nd NEODIMIO	61 (145) Pm PROMETIO	62 150.36 Sm SAMARIO	63 151.96 Eu EUROPIO	64 157.25 Gd GADOLINIO	65 158.93 Tb TERBIO	66 162.50 Dy DISPROSIO	67 164.93 Ho OLMIO	68 167.26 Er ERBIO	69 168.93 Tm TULIO	70 173.05 Yb ITTERBIO	71 174.97 Lu LUTEZIO
------------------------------------	---------------------------------	---------------------------------------	------------------------------------	-----------------------------------	-----------------------------------	-----------------------------------	-------------------------------------	----------------------------------	-------------------------------------	---------------------------------	---------------------------------	---------------------------------	------------------------------------	-----------------------------------

ATTINIDI

89 (227) Ac ATTINIO	90 232.04 Th TORIO	91 231.04 Pa PROTOATTINIO	92 238.03 U URANIO	93 (237) Np NETTUNIO	94 (244) Pu PLUTONIO	95 (243) Am AMERICIO	96 (247) Cm CURIO	97 (247) Bk BERKELIO	98 (251) Cf CALIFORNIO	99 (252) Es EINSTEINIO	100 (257) Fm FERMIO	101 (258) Md MENDELEVIO	102 (259) No NOBELIO	103 (262) Lr LAWRENTIO
----------------------------------	---------------------------------	--	---------------------------------	-----------------------------------	-----------------------------------	-----------------------------------	--------------------------------	-----------------------------------	-------------------------------------	-------------------------------------	----------------------------------	--------------------------------------	-----------------------------------	-------------------------------------

Copyright © 2012 Eni Generalic

(1) Pure Appl. Chem., 81, No. 11, 2131-2156 (2009)

Le masse atomiche relative sono espresse con cinque cifre significative. L'elemento non ha alcuni nuclidi stabili e un valore tra parentesi, e.g. [209], indica il numero totale dell'isotopo lungo-vivo dell'elemento. Tuttavia, tre elementi (Th, Pa ed U) hanno una composizione isotopica terrestre caratteristica e così loro massa atomica data.

tavola di Mendeleev

TAVOLA PERIODICA DEGLI ELEMENTI

<http://www.periodicdani.com/it/>

PERIODO	GRUPPO		GRUPPO IUPAC										GRUPPO CAS		GRUPPO															
	1	2	3	4	5	6	7	8	9	10	11	12	13	14	15	16	17	18												
	IA	IIA	IIIB	IVB	VB	VIB	VII B	VIII B	VIII B	VIII B	IB	IIB	IIIA	IVA	VA	VIA	VIIA	VIIIA												
1	1.0079 H IDROGENO												5 10.811 B BORO	6 12.01 C CARBONIO	7 14.007 N AZOTO	8 15.999 O OSSIGENO	9 18.998 F FLUORO	10 20.180 Ne NEO												
2	6.941 Li LITIO	9.0122 Be BERILLIO											13 26.982 Al ALLUMINIO	14 28.086 Si SILICIO	15 30.974 P FOSFORO	16 32.065 S SOLFO	17 35.453 Cl CLORO	18 39.948 Ar ARGO												
3	22.990 Na SODIO	24.305 Mg MAGNESIO											19 39.098 K POTASSIO	20 40.078 Ca CALCIO	21 44.956 Sc SCANDIO	22 47.867 Ti TITANIO	23 50.942 V VANADIO	24 51.996 Cr CROMO	25 54.938 Mn MANGANESE	26 55.845 Fe FERRO	27 58.933 Co COBALTO	28 58.693 Ni NICHEL	29 63.546 Cu RAME	30 65.38 Zn ZINCO	31 69.723 Ga GALLIO	32 72.64 Ge GERMANIO	33 74.922 As ARSENICO	34 78.96 Se SELENIO	35 79.904 Br BROMO	36 83.798 Kr CRIPTO
4	37 85.468 Rb RUBIDIO	87.62 Sr STRONZIO	39 88.906 Y ITTRIO	40 91.224 Zr ZIRCONIO	41 92.906 Nb NIOBIO	42 95.96 Mo MOLIBDENO	43 (98) Tc TECNETO	44 101.07 Ru RUTENIO	45 102.91 Rh RHODIO	46 106.42 Pd PALADIO	47 107.87 Ag ARGENTO	48 112.41 Cd CADMIO	49 114.82 In INDIO	50 118.71 Sn STAGNO	51 121.76 Sb ANTIMONIO	52 127.60 Te TELLURIO	53 126.90 I IODIO	54 131.29 Xe XENONO												
5	85 132.91 Cs CESIO	137.33 Ba BARIO	57-71 La-Lu Lantanidi	72 178.49 Hf HAFNIO	73 180.95 Ta TANTALIO	74 183.84 W WOLFRAMIO	75 186.21 Re RENEO	76 187 Os OSMIO	77 188.91 Ir IRIDIO	78 192.22 Pt PLATINO	79 197.04 Au ORO	80 200.59 Hg MERCURIO	81 204.38 Tl TALLIO	82 208.98 Pb PIOMBO	83 208.98 Bi BISMUTO	84 209 Po POLONIO	85 209 At ASTATO	86 210 Rn RADON												
6	87 (223) Fr FRANCIO	88 (226) Ra RADIO	89-103 Ac-Lr Attinidi	104 (267) Rf RUTHERFORDIO	105 (268) Db DUBNIO	106 (271) Sg SEABORGIO	107 (272) Bh BOHRIO	108 (277) Hs HASSIO	109 (276) Mt MEITNERIO	110 (281) Ds DARMSTADTIO	111 (280) Rg ROENTGENIO	112 (285) Cn COPERNICIO	113 (...) Uut UNUNTRO	114 (287) Fl FLEROVIO	115 (...) Uup UNUNPENTIO	116 (291) Lv LIVERMORIO	117 (...) Uus UNUNSEPTIO	118 (...) Uuo UNUNOCTIO												

Nitruro di Gallio GaN

LANTANIDI

57 138.91 La LANTANIO	58 140.12 Ce CERIO	59 140.91 Pr PRASEODIMIO	60 144.24 Nd NEODIMIO	61 (145) Pm PROMETIO	62 150.36 Sm SAMARIO	63 151.96 Eu EUROPIO	64 157.25 Gd GADOLINIO	65 158.93 Tb TERBIO	66 162.50 Dy DISPROSIO	67 164.93 Ho OLMIO	68 167.26 Er ERBIO	69 168.93 Tm TULIO	70 173.05 Yb ITTERBIO	71 174.97 Lu LUTEZIO
------------------------------------	---------------------------------	---------------------------------------	------------------------------------	-----------------------------------	-----------------------------------	-----------------------------------	-------------------------------------	----------------------------------	-------------------------------------	---------------------------------	---------------------------------	---------------------------------	------------------------------------	-----------------------------------

ATTINIDI

89 (227) Ac ATTINIO	90 232.04 Th TORIO	91 231.04 Pa PROTOATTINIO	92 238.03 U URANIO	93 (237) Np NETTUNIO	94 (244) Pu PLUTONIO	95 (243) Am AMERICIO	96 (247) Cm CURIO	97 (247) Bk BERKELIO	98 (251) Cf CALIFORNIO	99 (252) Es EINSTEINIO	100 (257) Fm FERMIO	101 (258) Md MENDELEVIO	102 (259) No NOBELIO	103 (262) Lr LAWRENTIO
----------------------------------	---------------------------------	--	---------------------------------	-----------------------------------	-----------------------------------	-----------------------------------	--------------------------------	-----------------------------------	-------------------------------------	-------------------------------------	----------------------------------	--------------------------------------	-----------------------------------	-------------------------------------

Copyright © 2012 Eni Generali

(1) Pure Appl. Chem., 81, No. 11, 2131-2156 (2009)
Le masse atomiche relative sono espresse con cinque cifre significative. L'elemento non ha alcuni nuclidi stabili e un valore tra parentesi, e.g. [209], indica il numero totale dell'isotopo lungo-vivo dell'elemento. Tuttavia, tre elementi (Th, Pa ed U) hanno una composizione isotopica terrestre caratteristica e così loro massa atomica data.

tavola di Mendeleev

TAVOLA PERIODICA DEGLI ELEMENTI

<http://www.periodic-table.com/it/>

GRUPPO	1	2	GRUPPO IUPAC										13	14	15	16	17	18												
	IA	IIA	3	4	5	6	7	VIII B		9	10	11	12	IIIA	IVA	VA	VIA	VIIA	VIIIA											
PERIODO	1	2	3	4	5	6	7	8	9	10	11	12	13	14	15	16	17	18												
1	1 1.0079 H IDROGENO													5 10.811 B BORO	6 12.011 C CARBONIO	7 14.007 N AZOTO	8 15.999 O OSSIGENO	9 18.998 F FLUORO	10 20.180 Ne NEO											
2	3 6.941 Li LITIO	4 9.0122 Be BERILLIO											13 26.982 Al ALLUMINIO	14 28.086 Si SILICIO	15 30.974 P FOSFORO	16 32.065 S SOLFO	17 35.453 Cl CLORO	18 39.948 Ar ARGO												
3	11 22.990 Na SODIO	12 24.305 Mg MAGNESIO											19 39.098 K POTASSIO	20 40.078 Ca CALCIO	21 44.956 Sc SCANDIO	22 47.867 Ti TITANIO	23 50.942 V VANADIO	24 51.996 Cr CROMO	25 54.938 Mn MANGANESE	26 55.845 Fe FERRO	27 58.933 Co COBALTO	28 58.693 Ni NICHEL	29 63.546 Cu RAME	30 65.38 Zn ZINCO	31 69.723 Ga GALLIO	32 72.64 Ge GERMANIO	33 74.922 As ARSENICO	34 78.96 Se SELENIO	35 79.904 Br BROMO	36 83.798 Kr CRIPTO
4	37 85.468 Rb RUBIDIO	38 87.62 Sr STRONZIO	39 88.906 Y ITTRIO	40 91.224 Zr ZIRCONIO	41 92.906 Nb NIOBIO	42 95.96 Mo MOLIBDENO	43 (98) Tc TECNETO	44 101.07 Ru RUTENIO	45 102.91 Rh RODIO	46 106.42 Pd PALLADIO	47 107.87 Ag ARGENTO	48 112.41 Cd CADMIO	49 114.82 In INDIO	50 118.71 Sn STAGNO	51 121.76 Sb ANTIMONIO	52 127.60 Te TELLURIO	53 126.90 I IODIO	54 131.29 Xe XENO												
5	55 132.91 Cs CESIO	56 137.33 Ba BARIO	57-71 La-Lu Lantanidi	72 178.49 Hf HAFNIO	73 180.95 Ta TANTALO	74 183.84 W WOLFRAMIO	75 186.21 Re RENEO	76 190.23 Os OSMIO	77 192.22 Ir IRIDIO	78 195.08 Pt PLATINO	79 196.97 Au ORO	80 200.59 Hg MERCURIO	81 204.38 Tl TALLIO	82 207.2 Pb PIOMBO	83 208.98 Bi BISMUTO	84 (209) Po POLONIO	85 (210) At ASTATO	86 (222) Rn RADON												
6	87 (223) Fr FRANCIO	88 (226) Ra RADIO	89-103 Ac-L Attinidi																											
7																														

Fosforo di Indio InP

LANTANIDI

57 138.91 La LANTANIO	58 140.12 Ce CERIO	59 140.91 Pr PRASEODIMIO	60 144.24 Nd NEODIMIO	61 (145) Pm PROMETIO	62 150.36 Sm SAMARIO	63 151.96 Eu EUROPIO	64 157.25 Gd GADOLINIO	65 158.93 Tb TERBIO	66 162.50 Dy DISPROSIO	67 164.93 Ho OLMIO	68 167.26 Er ERBIO	69 168.93 Tm TULIO	70 173.05 Yb ITTERBIO	71 174.97 Lu LUTEZIO
------------------------------------	---------------------------------	---------------------------------------	------------------------------------	-----------------------------------	-----------------------------------	-----------------------------------	-------------------------------------	----------------------------------	-------------------------------------	---------------------------------	---------------------------------	---------------------------------	------------------------------------	-----------------------------------

ATTINIDI

89 (227) Ac ATTINIO	90 232.04 Th TORIO	91 231.04 Pa PROTOATTINIO	92 238.03 U URANIO	93 (237) Np NETTUNIO	94 (244) Pu PLUTONIO	95 (243) Am AMERICIO	96 (247) Cm CURIO	97 (247) Bk BERKELIO	98 (251) Cf CALIFORNIO	99 (252) Es EINSTEINIO	100 (257) Fm FERMIO	101 (258) Md MENDELEVIO	102 (259) No NOBELIO	103 (262) Lr LAWRENTIO
----------------------------------	---------------------------------	--	---------------------------------	-----------------------------------	-----------------------------------	-----------------------------------	--------------------------------	-----------------------------------	-------------------------------------	-------------------------------------	----------------------------------	--------------------------------------	-----------------------------------	-------------------------------------

Copyright © 2012 Eni Generalic

(1) Pure Appl. Chem., 81, No. 11, 2131-2156 (2009)

Le masse atomiche relative sono espresse con cinque cifre significative. L'elemento non ha alcuni nuclidi stabili e un valore tra parentesi, e.g. [209], indica il numero totale dell'isotopo lungo-vivo dell'elemento. Tuttavia, tre elementi (Th, Pa ed U) hanno una composizione isotopica terrestre caratteristica e così loro massa atomica data.

tavola di Mendeleev

TAVOLA PERIODICA DEGLI ELEMENTI

<http://www.periodni.com>

PERIODO	GRUPPO		GRUPPO IUPAC										GRUPPO CAS						
	1	2	3	4	5	6	7	8	9	10	11	12	13	14	15	16	17	18	
	IA	IIA	IIIB	IVB	VB	VIB	VII B	VIII B	VIII B	VIII B	IB	IIB	IIIA	IVA	VA	VIA	VIIA	VIIIA	
1	1.0079 H IDROGENO																		2 4.0026 He ELIO
2	3 6.941 Li LITIO	4 9.0122 Be BERILLIO											5 10.811 B BORO	6 12.011 C CARBONIO	7 14.007 N AZOTO	8 15.999 O OSSIGENO	9 18.998 F FLUORO	10 20.180 Ne NEO	
3	11 22.990 Na SODIO	12 24.305 Mg MAGNESIO											13 26.982 Al ALLUMINIO	14 28.086 Si SILICIO	15 30.974 P FOSFORO	16 32.065 S SOLFO	17 35.453 Cl CLORO	18 39.948 Ar ARGO	
4	19 39.098 K POTASSIO	20 40.078 Ca CALCIO	21 44.956 Sc SCANDIO	22 47.867 Ti TITANIO	23 50.942 V VANADIO	24 51.996 Cr CROMO	25 54.938 Mn MANGANESE	26 55.845 Fe FERRO	27 58.933 Co COBALTO	28 58.693 Ni NICHEL	29 63.546 Cu RAME	30 65.38 Zn ZINCO	31 69.723 Ga GALLIO	32 72.64 Ge GERMANIO	33 74.922 As ARSENICO	34 78.96 Se SELENIO	35 79.904 Br BROMO	36 83.798 Kr CRIPTO	
5	37 85.468 Rb RUBIDIO	38 87.62 Sr STRONZIO	39 88.906 Y ITTRIO	40 91.224 Zr ZIRCONIO	41 92.906 Nb NIOBIO	42 95.96 Mo MOLIBDENO	43 (98) Tc TECNETO	44 101.07 Ru RUTENIO	45 102.91 Rh RODIO	46 106.42 Pd PALLADIO	47 107.87 Ag ARGENTO	48 112.41 Cd CADMIO	49 114.82 In INDIO	50 118.71 Sn STAGNO	51 121.76 Sb ANTIMONIO	52 127.60 Te TELLURIO	53 126.90 I IODIO	54 131.29 Xe XENO	
6	55 132.91 Cs CESIO	56 137.33 Ba BARIO	57-71 La-Lu Lantanidi	72 178.49 Hf HAFNIO	73 180.95 Ta TANTALO	74 183.84 W WOLFRAMIO	75 186.21 Re RENEO	76 190.23 Os OSMIO	77 192.22 Ir IRIDIO	78 195.08 Pt PLATINO	79 196.97 Au ORO	80 200.59 Hg MERCURIO	81 204.38 Tl TALLIO	82 207.2 Pb PIOMBO	83 208.98 Bi BISMUTO	84 (209) Po POLONIO	85 (210) At ASTATO	86 (222) Rn RADON	
7	87 (223) Fr FRANCIO	88 (226) Ra RADIO	89-103 Ac-Lr Attinidi																

eccetera eccetera eccetera

LANTANIDI

57 138.91 La LANTANIO	58 140.12 Ce CERIO	59 140.91 Pr PRASEODIMIO	60 144.24 Nd NEODIMIO	61 (145) Pm PROMETIO	62 150.36 Sm SAMARIO	63 151.96 Eu EUROPIO	64 157.25 Gd GADOLINIO	65 158.93 Tb TERBIO	66 162.50 Dy DISPROSIO	67 164.93 Ho OLMIO	68 167.26 Er ERBIO	69 168.93 Tm TULIO	70 173.05 Yb ITTERBIO	71 174.97 Lu LUTEZIO
------------------------------------	---------------------------------	---------------------------------------	------------------------------------	-----------------------------------	-----------------------------------	-----------------------------------	-------------------------------------	----------------------------------	-------------------------------------	---------------------------------	---------------------------------	---------------------------------	------------------------------------	-----------------------------------

ATTINIDI

89 (227) Ac ATTINIO	90 232.04 Th TORIO	91 231.04 Pa PROTOATTINIO	92 238.03 U URANIO	93 (237) Np NETTUNIO	94 (244) Pu PLUTONIO	95 (243) Am AMERICIO	96 (247) Cm CURIO	97 (247) Bk BERKELIO	98 (251) Cf CALIFORNIO	99 (252) Es EINSTEINIO	100 (257) Fm FERMIO	101 (258) Md MENDELEVIO	102 (259) No NOBELIO	103 (262) Lr LAWRENTIO
----------------------------------	---------------------------------	--	---------------------------------	-----------------------------------	-----------------------------------	-----------------------------------	--------------------------------	-----------------------------------	-------------------------------------	-------------------------------------	----------------------------------	--------------------------------------	-----------------------------------	-------------------------------------

Copyright © 2012 Eni Generalic

(1) Pure Appl. Chem., 81, No. 11, 2131-2156 (2009)

Le masse atomiche relative sono espresse con cinque cifre significative. L'elemento non ha alcuni nuclidi stabili e un valore tra parentesi, e.g. [209], indica il numero totale dell'isotopo lungo-vivo dell'elemento. Tuttavia, tre elementi (Th, Pa ed U) hanno una composizione isotopica terrestre caratteristica e così loro massa atomica data.

Dispositivi Optoelettronici: principi fisici

Fotoconduttività (fotoresistore, tubo a camera fotoconduttiva, charge-coupled imaging devices)

Effetto Lossev o combinazione radiativa (LED)

Effetto Fotoelettrico o Fotovoltaico (fotodiodi, fototransistori, fotomoltiplicatori, circuiti ottici integrati)

Emissione Stimolata (LASER, diodo LASER)

Fotoemissività (tubo a camera fotoemissiva)

Modulazione Elettronica (LCD)

.....

Fotoconduttività

Molti materiali cambiano resistività se illuminati con la luce

Banda di conduzione

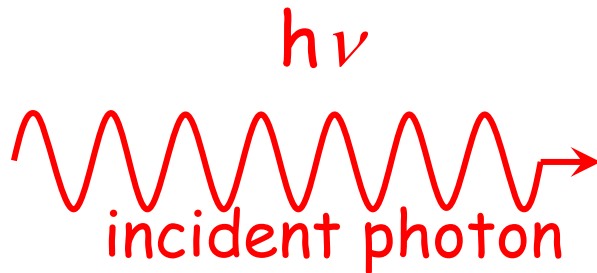

Banda di valenza

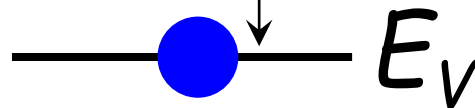

ν frequenza

$$h\nu > \Delta E$$

$$h = 6,6 \cdot 10^{-34} \text{ Js}$$

Fotoconduttività

Molti materiali cambiano resistività se illuminati con la luce

Banda di conduzione

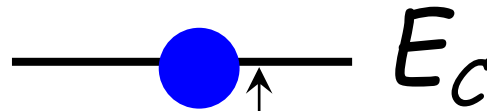

ν frequenza

$$h\nu > \Delta E$$

$$h = 6,6 \cdot 10^{-34} \text{ Js}$$

Banda di valenza

Fotoresistore

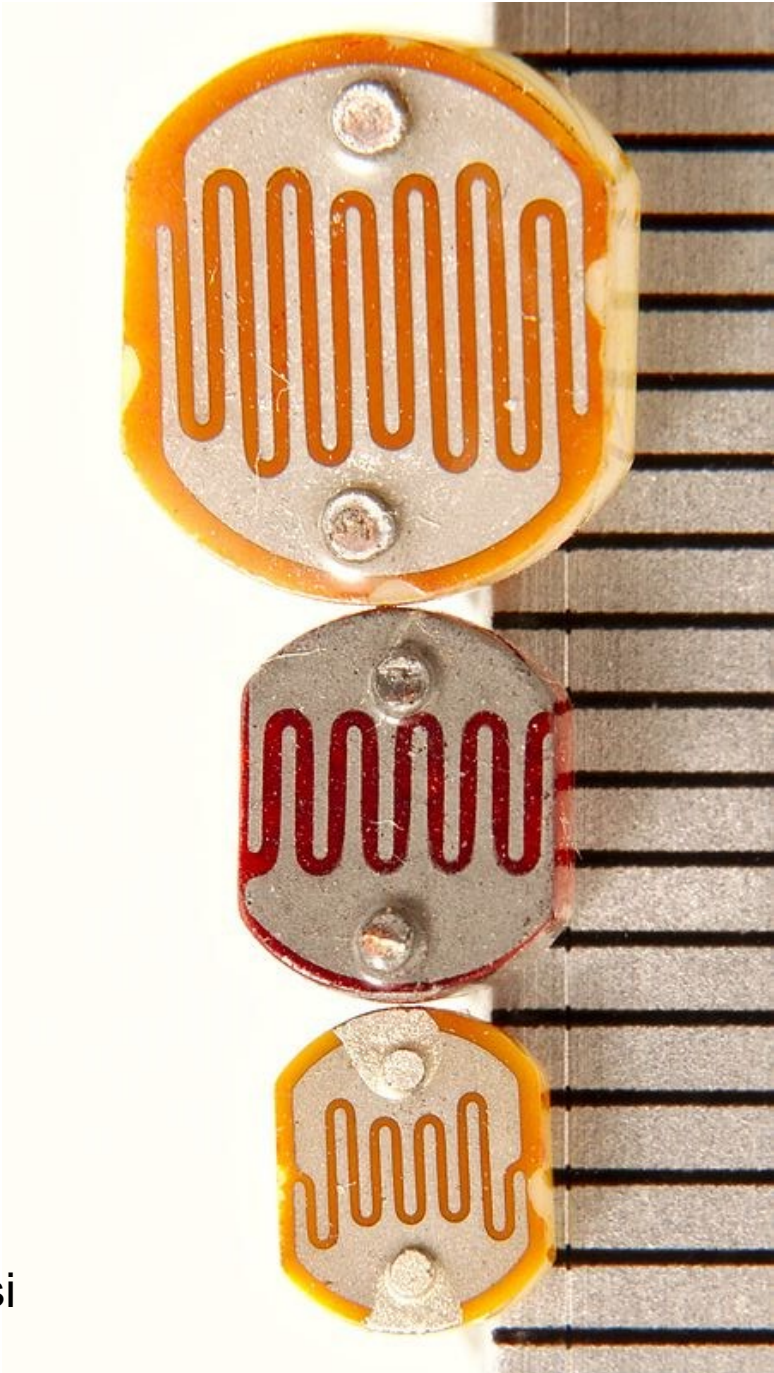
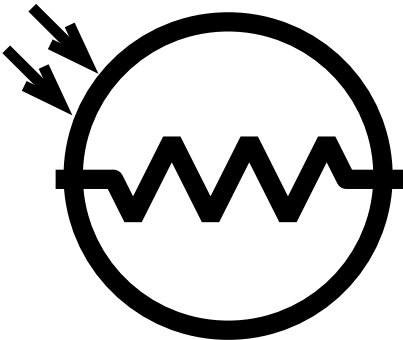

https://commons.wikimedia.org/wiki/File:Photoresistors_-_three_sizes_-_mm_scale.jpg



Esperienza di laboratorio: misure con fotoresistore



Strumentazione



**Multimetro
digitale**

http://www.unipv.it/lde/strumentazione_strum_banco/multimetro34450A.pdf

http://www.unipv.it/lde/didattica_elettronica/13MultimetroKeysight34450A.pdf





MULTIMETRO DIGITALE

Misure V e I (DC e AC), misura resistenza, altro...

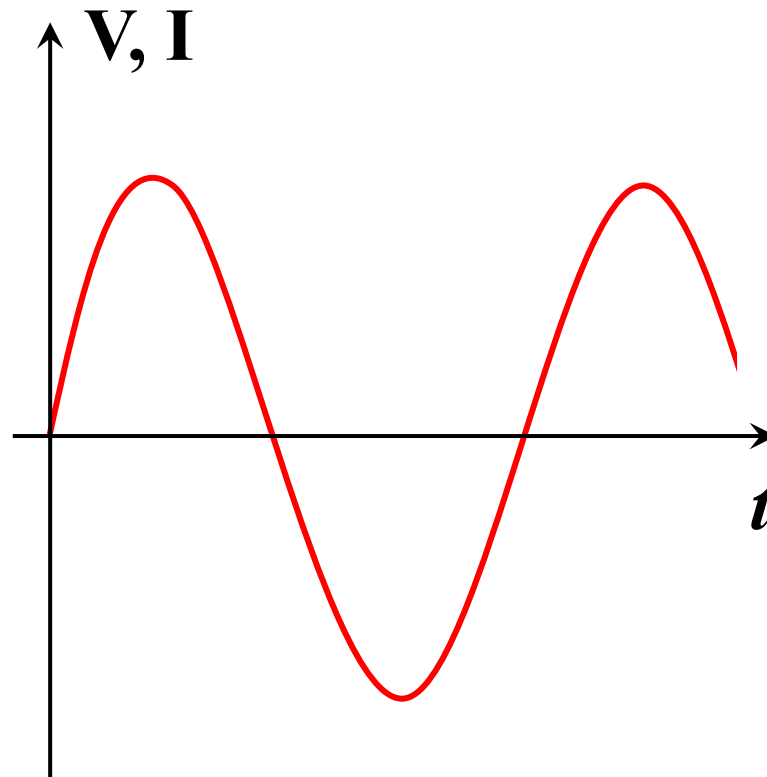
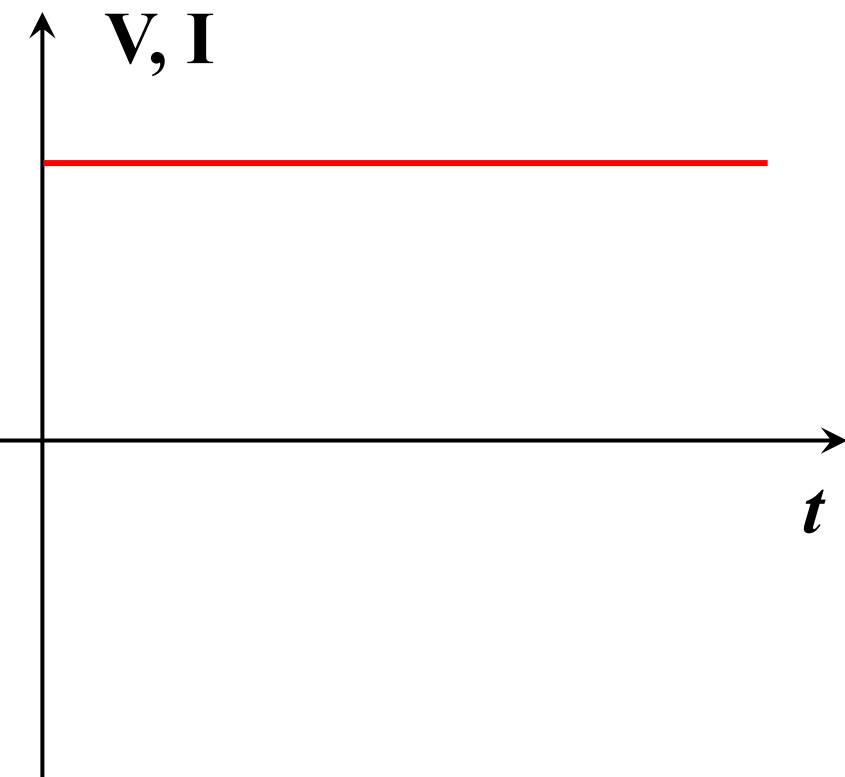



MULTIMETRO DIGITALE

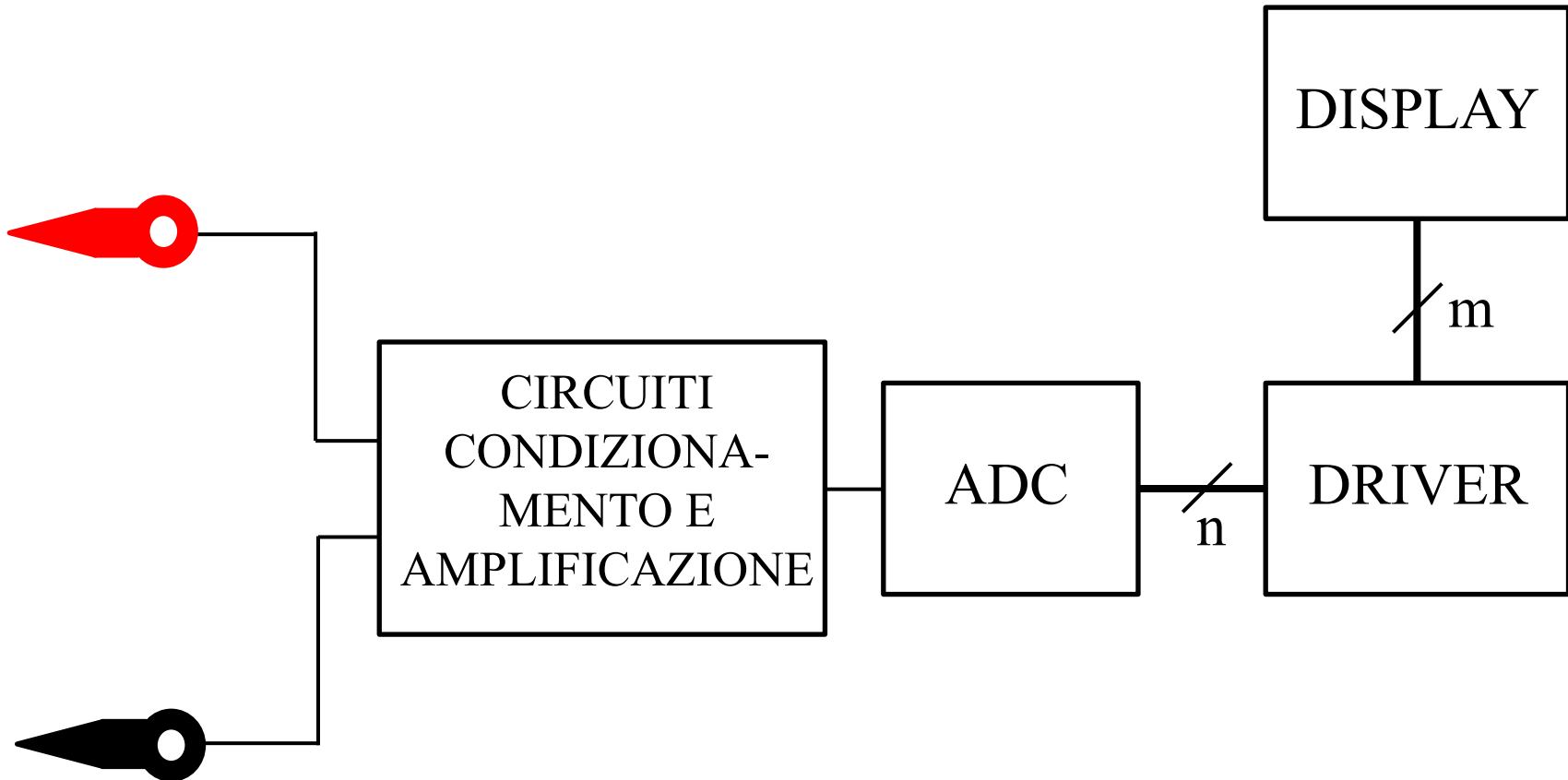



MISURA DI RESISTENZA OHM(M)ETRO

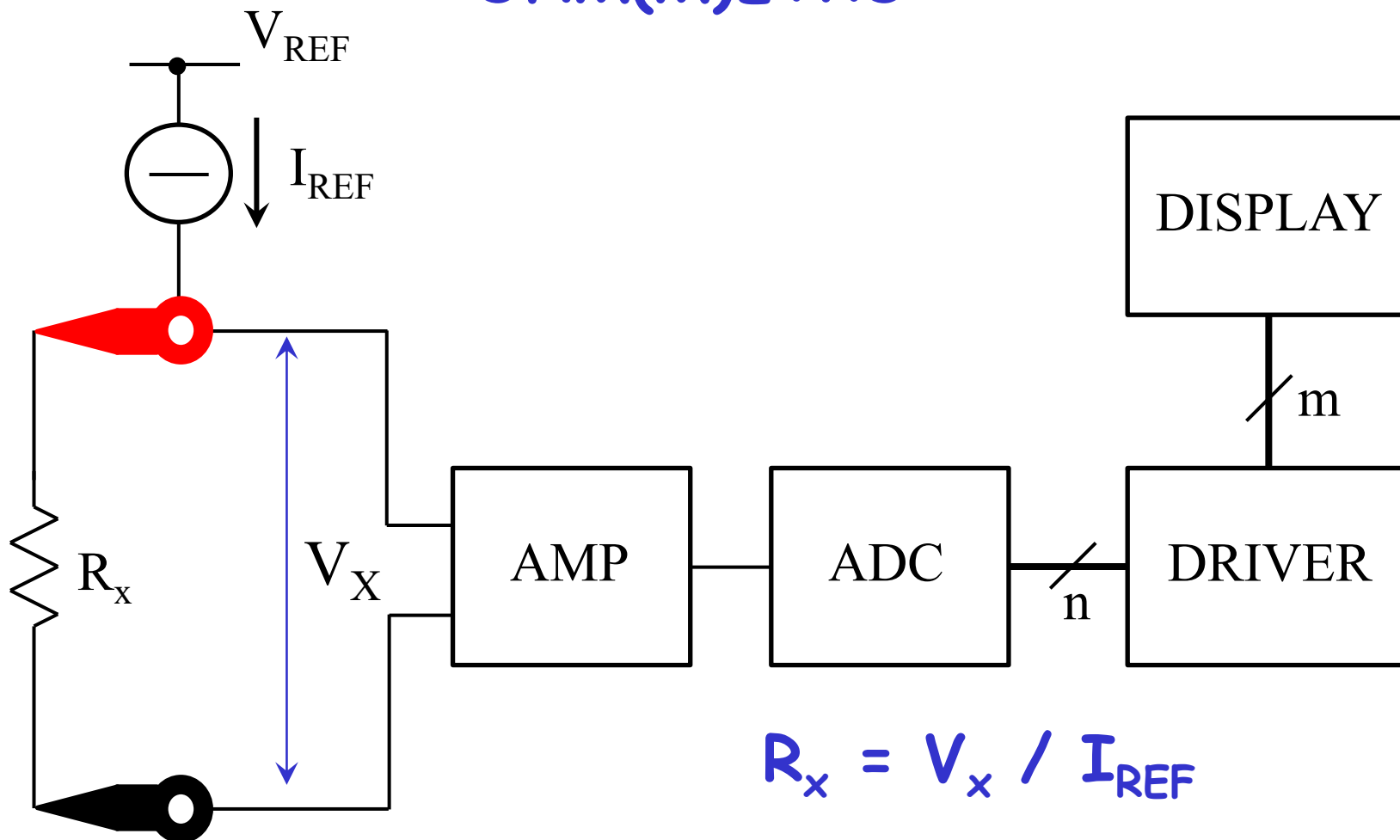



ACCENDERE!!!

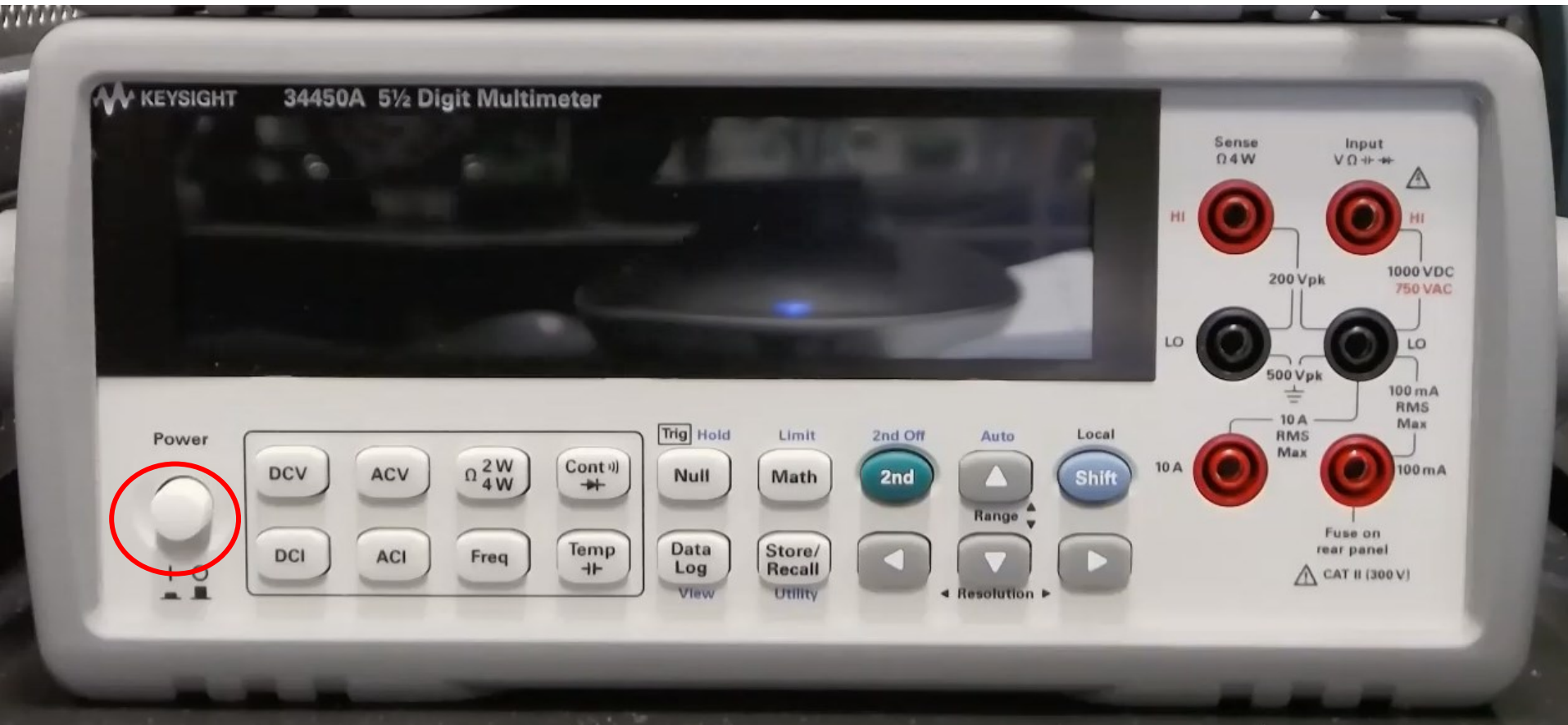



MISURA DI RESISTENZA OHM(M)ETRO

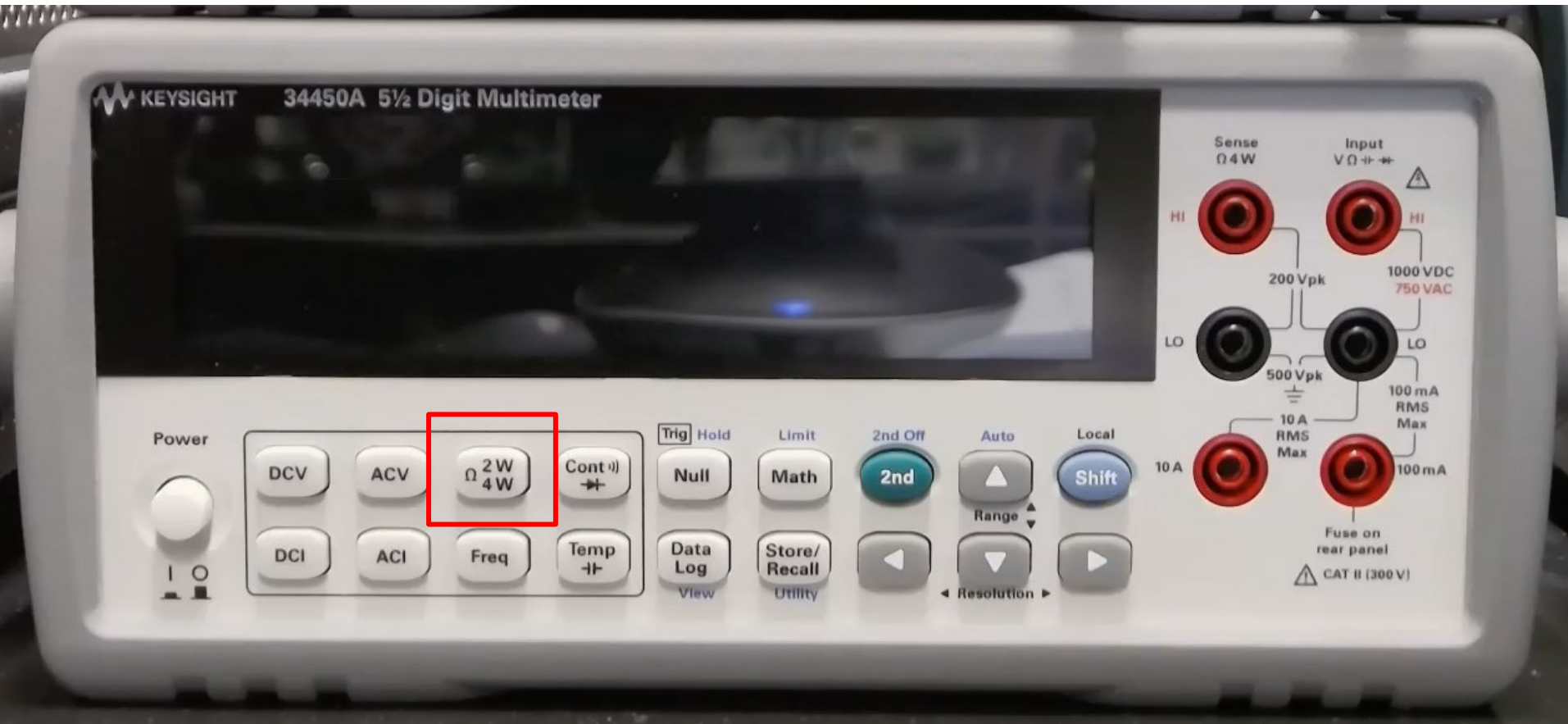





MISURA RESISTENZA





UNIVERSITÀ DI PAVIA
Dipartimento di
Ingegneria Industriale
e dell'Informazione

Basetta sperimentale (breadboard)

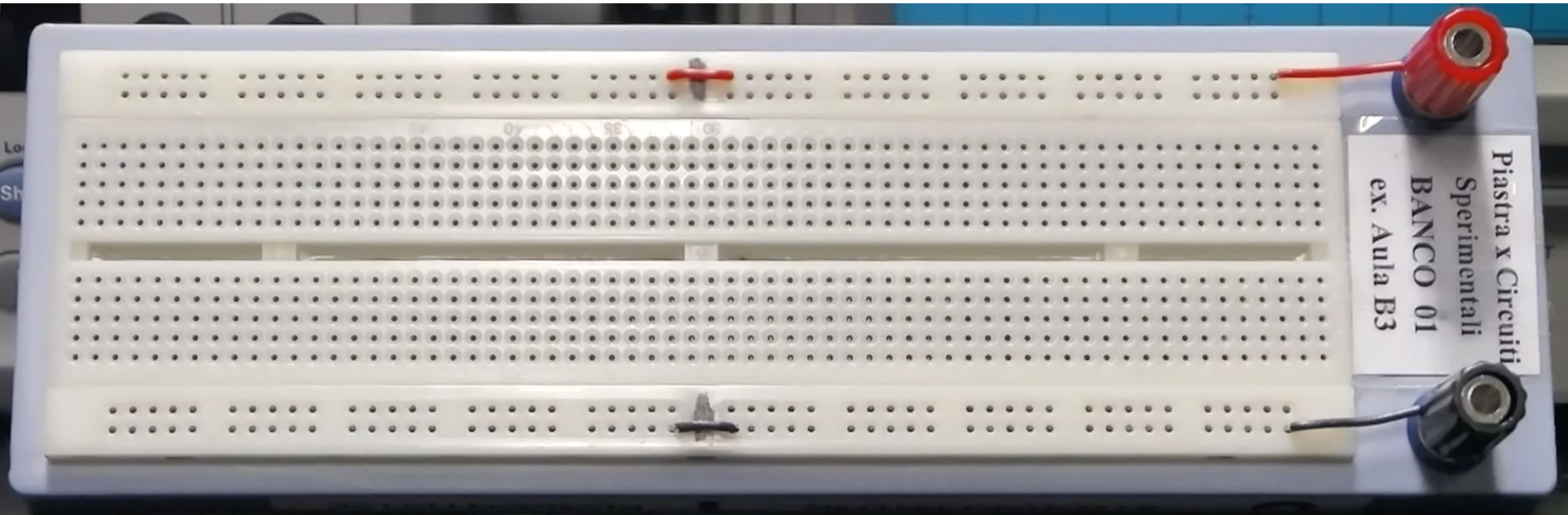



UNIVERSITÀ DI PAVIA
Dipartimento di
Ingegneria Industriale
e dell'Informazione

Basetta sperimentale (breadboard)

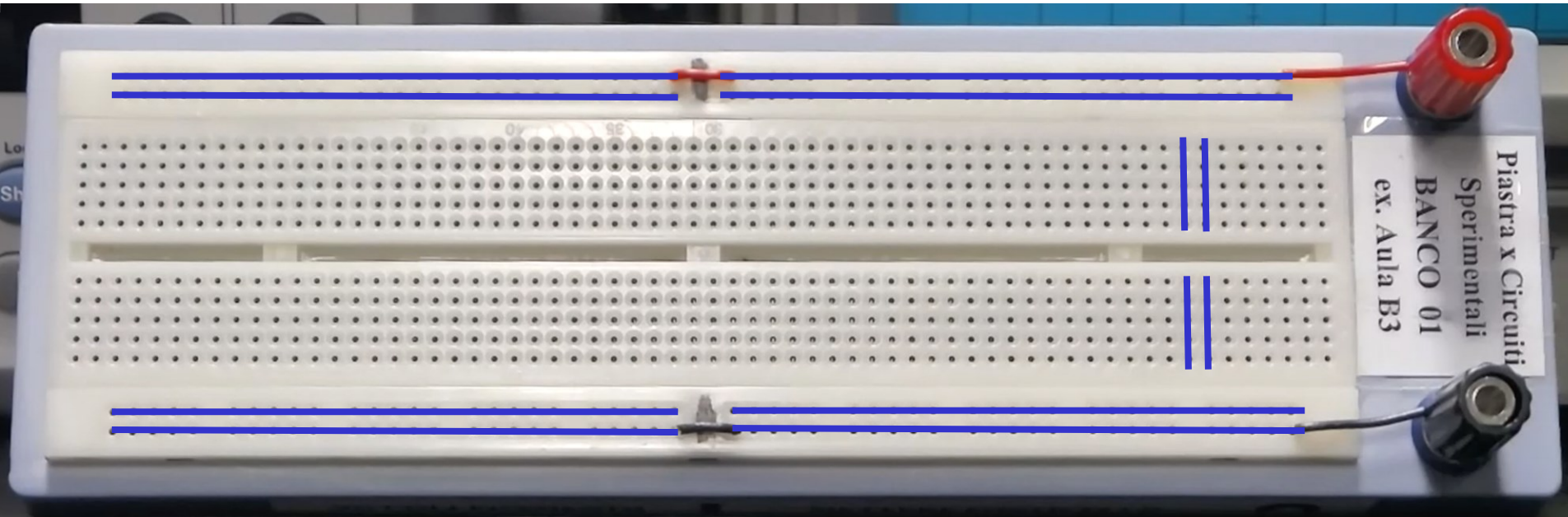



UNIVERSITÀ DI PAVIA
Dipartimento di
Ingegneria Industriale
e dell'Informazione

Basetta sperimentale (breadboard)

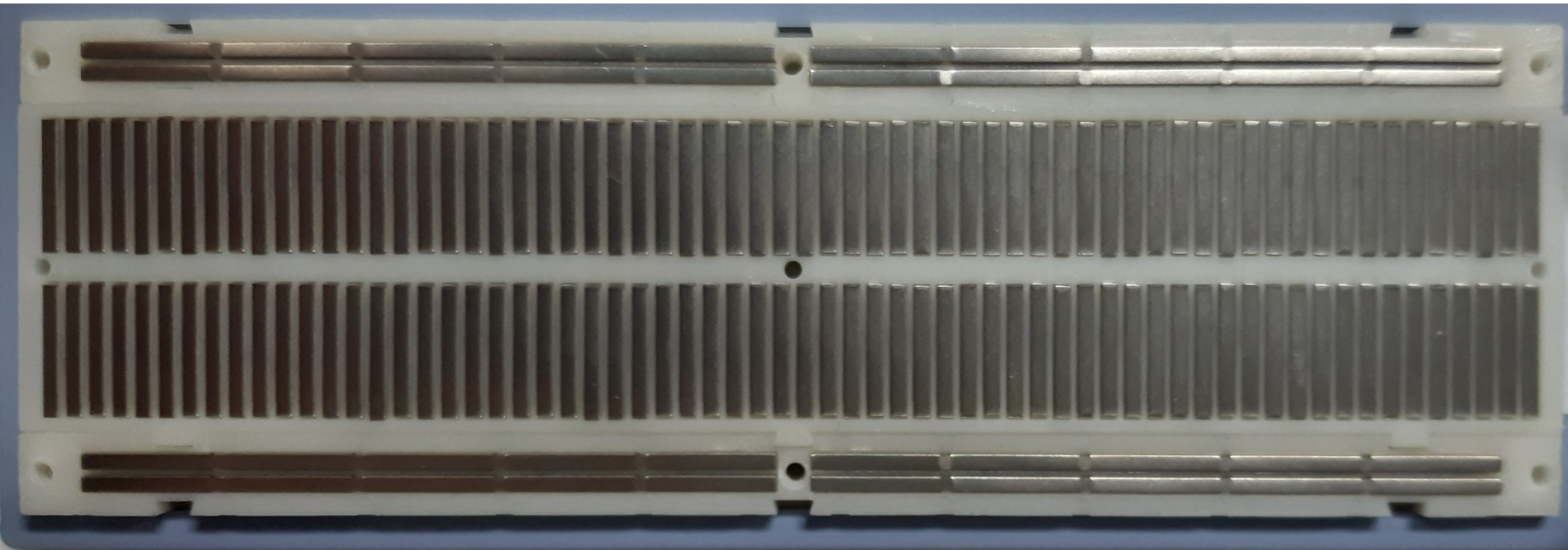



Basetta sperimentale (breadboard)

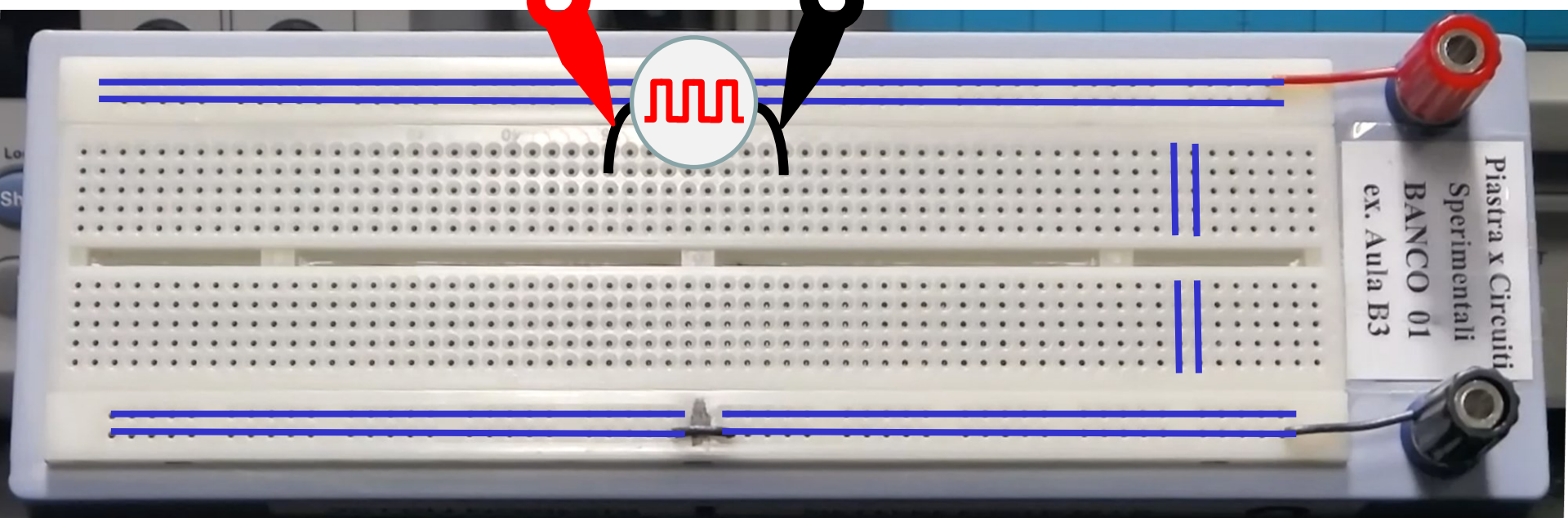
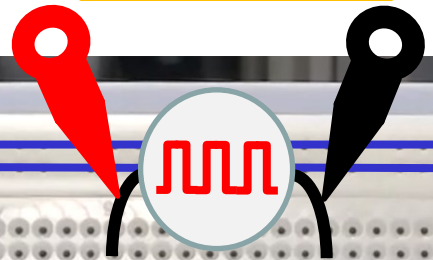
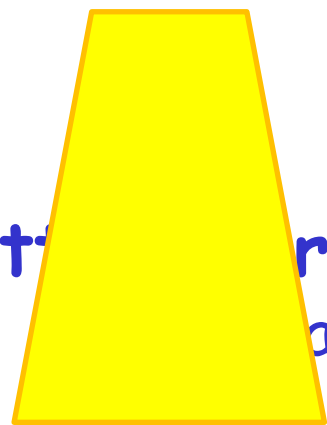

Dispositivi Optoelettronici: principi fisici

Fotoconduttività (fotoresistore, tubo a camera fotoconduttiva, charge-coupled imaging devices)

Effetto Lossev o combinazione radiativa (LED)

Effetto Fotoelettrico o Fotovoltaico (fotodiodi, fototransistori, fotomoltiplicatori, circuiti ottici integrati)

Emissione Stimolata (LASER, diodo LASER)

Fotoemissività (tubo a camera fotoemissiva)

Modulazione Elettronica (LCD)

.....

Charge-Coupled imaging Devices CCD

Fotoconduttività (fotorestore, tubo a camera fotoconduttiva, charge-coupled imaging devices)

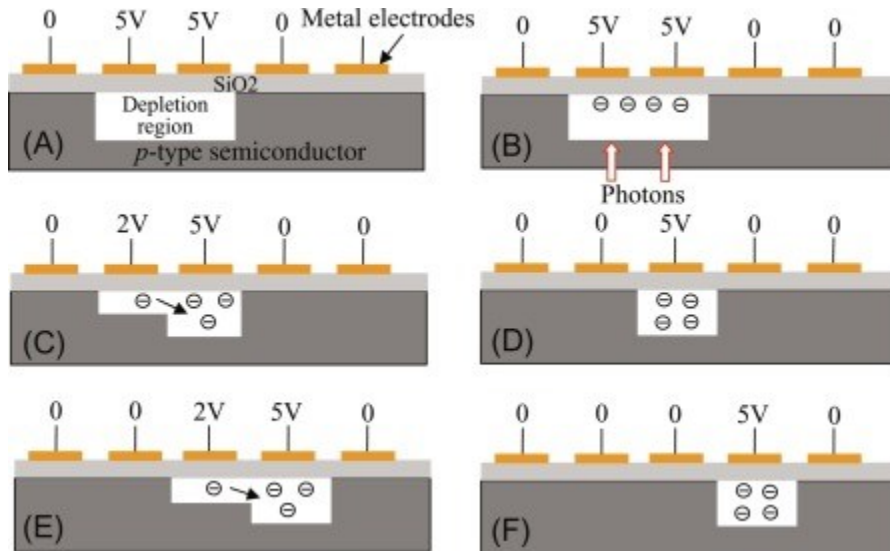

Sensori a pixel attivi
(effetto fotovoltaico)

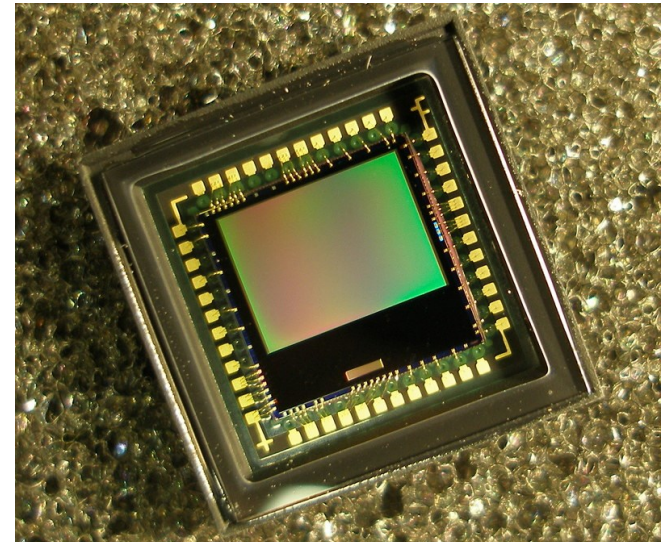

<https://www.sciencedirect.com/topics/engineering/charge-coupled-device>

Dispositivi Optoelettronici: principi fisici

Fotoconduttività (fotoresistore, tubo a camera fotoconduttiva, charge-coupled imaging devices)

Effetto Lossev o combinazione radiativa (LED)

Effetto Fotoelettrico o Fotovoltaico (fotodiodi, fototransistori, fotomoltiplicatori, circuiti ottici integrati)

Emissione Stimolata (LASER, diodo LASER)

Fotoemissività (tubo a camera fotoemissiva)

Modulazione Elettronica (LCD)

.....

DIODO A SEMICONDUCTORE (1)

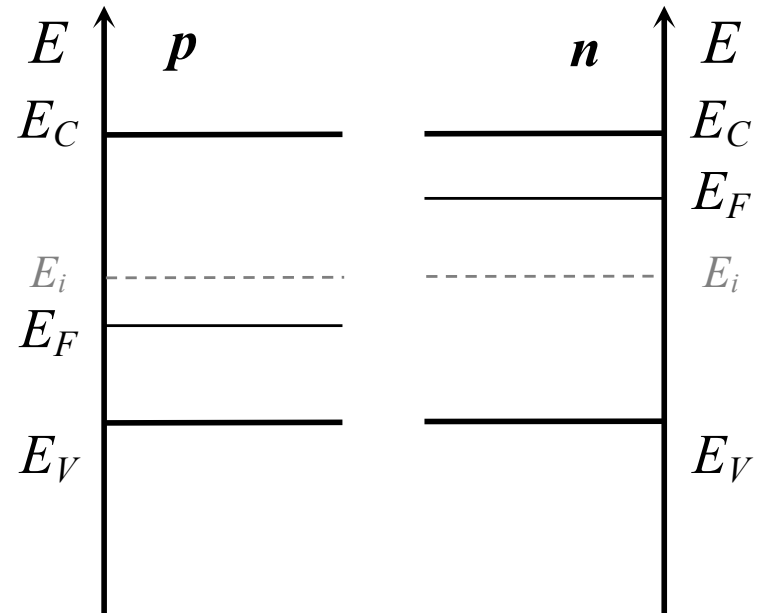
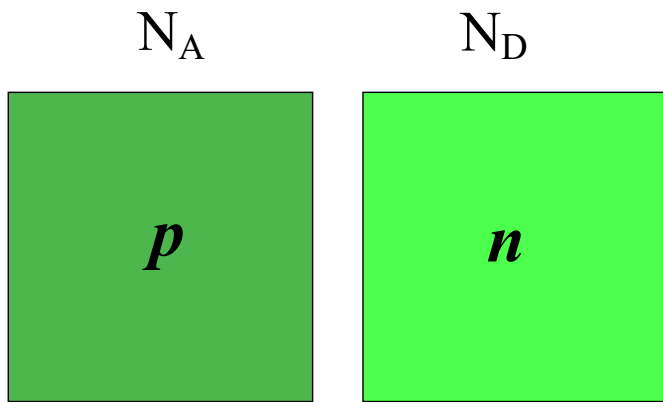

$$f(\epsilon) = \frac{1}{e^{(\epsilon - \mu)/kT} + 1}$$

Il livello di energia di Fermi serve per calcolare la probabilità che un dato stato di energia E sia occupato

DIODO A SEMICONDUTTORE (2)

Giunzione p-n

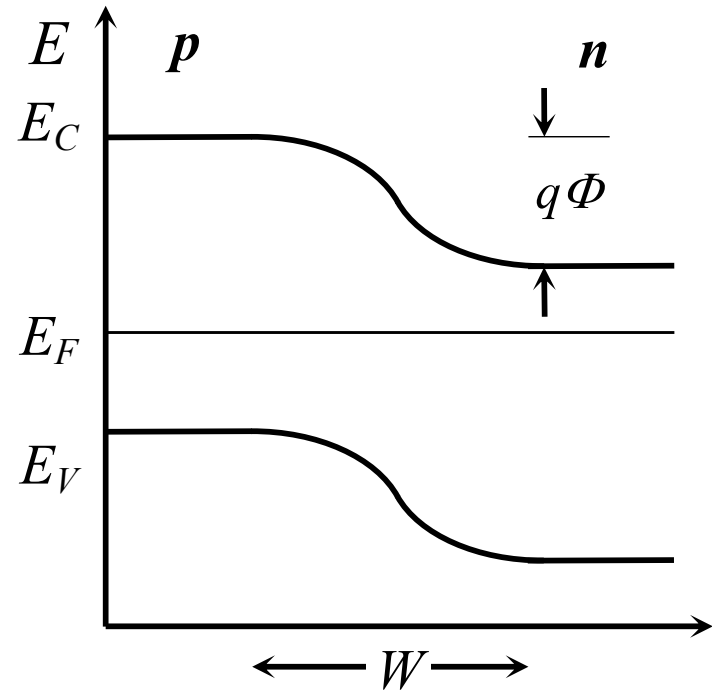
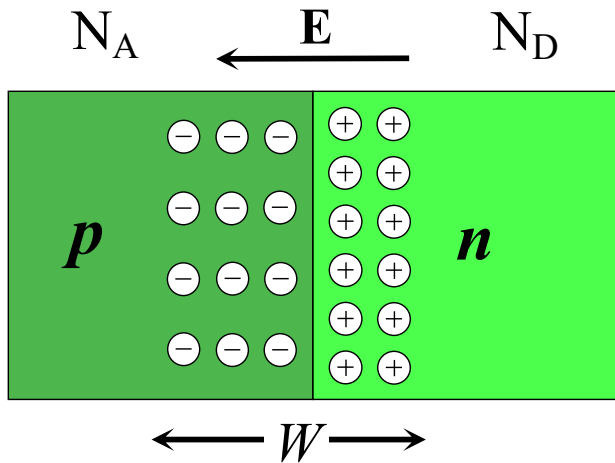

L'applicazione di un potenziale esterno V modifica l'altezza della barriera di potenziale Φ

DIODO A SEMICONDUCTORE (3)

Giunzione p-n $I = I_S \left(e^{\frac{qV}{\eta kT}} - 1 \right)$ (corrente polarizzazione diretta $\eta \in [1,2]$)

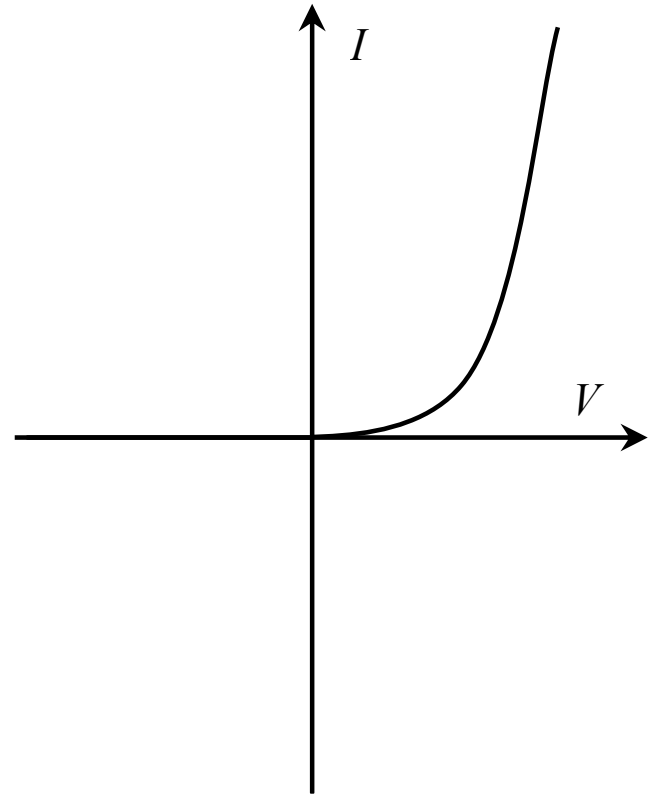
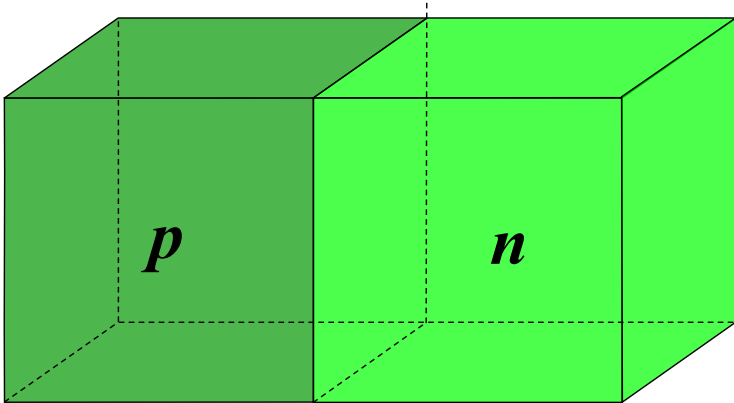



LED (Light Emitting Diode)

dispositivo optoelettronico (1962)
converte corrente elettrica in luce

Materiale semiconduttore

2014 Nobel per la Fisica Akasaki Amano Nakamura

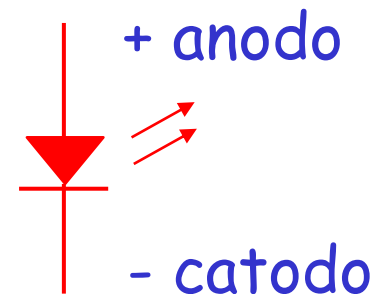

Effetto Lossev o combinazione radiativa

Gli elettroni nel semiconduttore si ricombinano con le lacune, rilasciando energia sotto forma di fotoni

Solo nei materiali a bandgap diretto

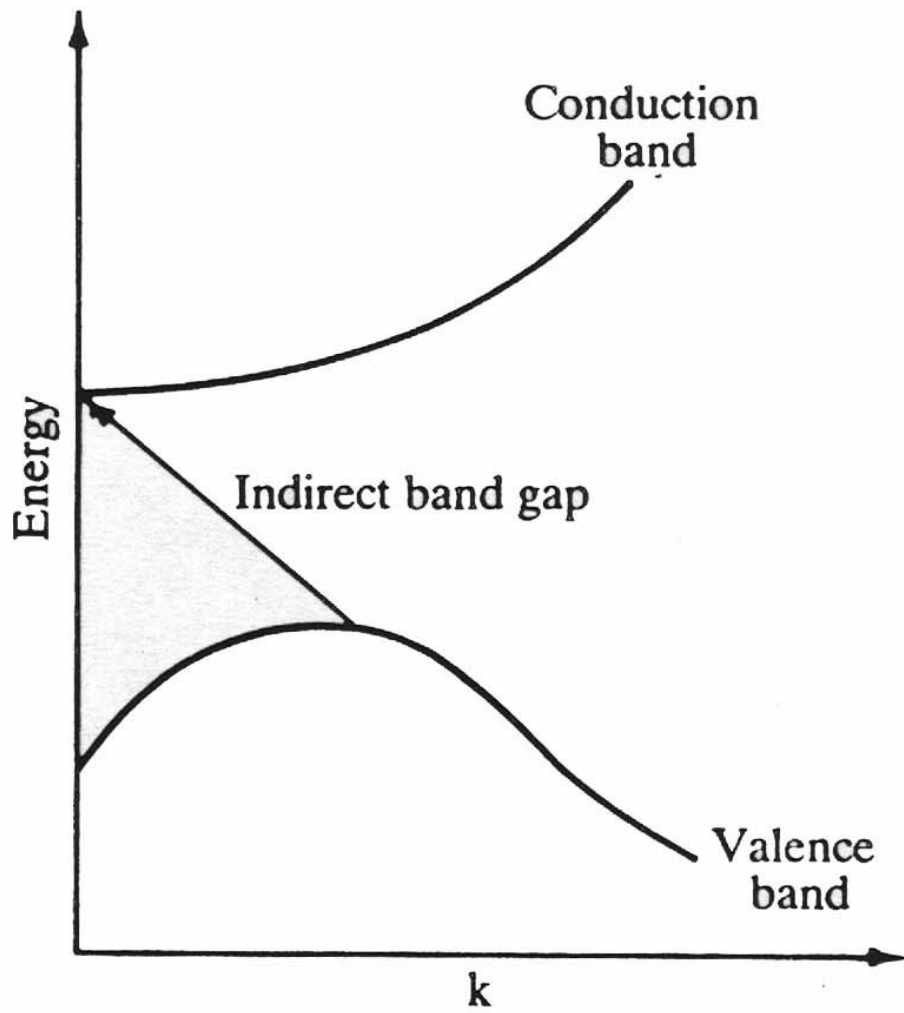
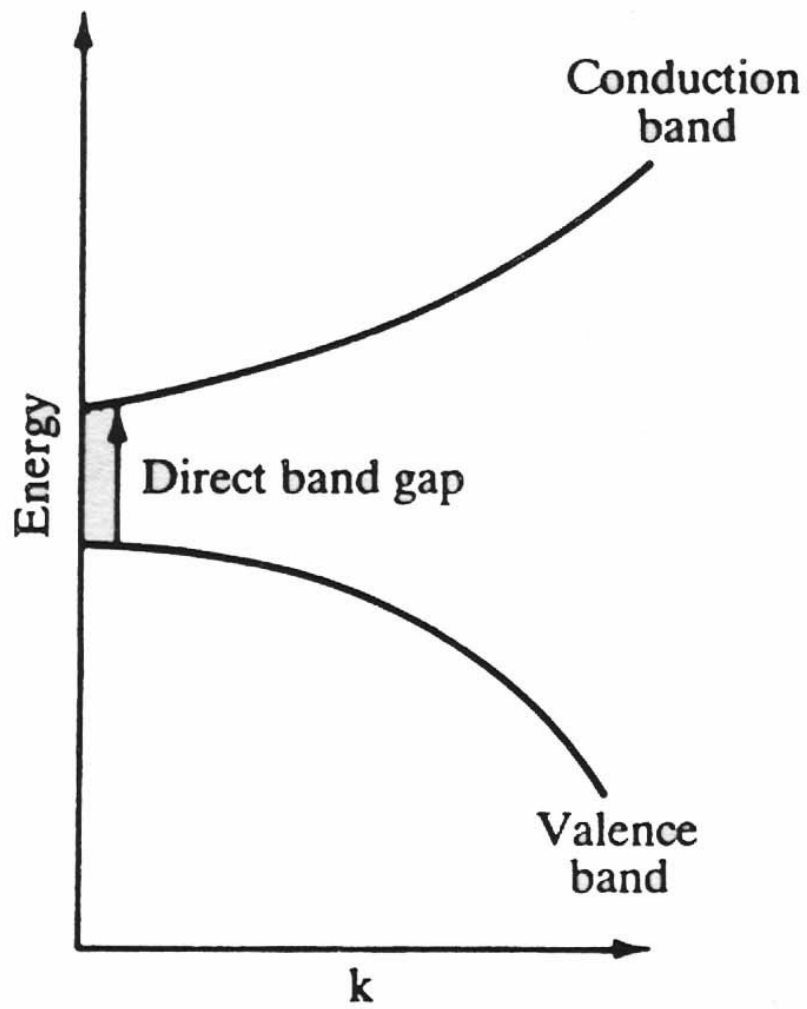

Effetto Lossev o combinazione radiativa

Gli elettroni nel semiconduttore si ricombinano con le lacune, rilasciando energia sotto forma di fotoni

Solo nei materiali a bandgap diretto

Nei materiali in cui il processo non è radiativo viene generato un fonone (calore). Esempio: silicio e germanio

I LED emettono su un ristretto intervallo di frequenze, che dipende dall'energia del band gap

Combinazione radiativa

Banda di conduzione

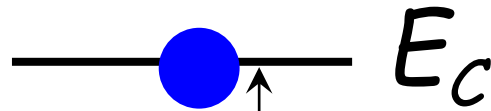

Banda di valenza

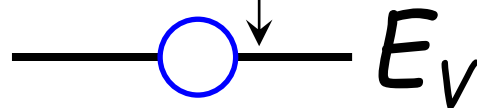

ν frequenza

$$h\nu = \Delta E$$

$$h = 6,6 \cdot 10^{-34} \text{ Js}$$

		LED Chip Code	Peak Wave length (nm)	Dominant Wave length (nm)	Color Name	Nominal Fwd Voltage (V _f @20ma)	Intensity (mcd) 5mm LEDs (For Reference)	Radiant Power mW/sr	LED Die Material
851	IR	IR851	843	N/A	Infrared	1.7	N/A	86mW@50mA	GaAlAs/GaAs
0UR		R3KF/R6	654	641	Ultra Red	1.9	1000mcd@20mA	13mW@20mA	GaAlAs/GaAlAs
00R		R3/R4/R5	640	625	HE Red	2.0	220mcd@20mA	1.8mW@20mA	GaAsP/GaP
0ER		E3K	634	624	Super E.Red	2.2	8000mcd@20mA	45mW@20mA	InGaAlP
0UO		O3KF	616	610	Super Orange	2.0	2000mcd@20mA	7mW@20mA	InGaAlP
00O		O4/O5	609	604	Orange	2.0	220mcd@20mA	0.7mW@20mA	GaAsP/GaP
0UY		Y3KF	598	593	Super Yellow	2.0	5000mcd@20mA	10mW@20mA	InGaAlP
0PY		Y3KH	592	589	Super P.Yellow	2.3	4000mcd@20mA	8mW@20mA	InGaAlP
00Y		Y3/Y4/Y5	582	584	Yellow	2.1	170mcd@20mA	0.3mW@20mA	GaAsP/GaP
0UG		G1K	575	573	Super L.Green	2.0	1800mcd@20mA	3mW@20mA	InGaAlP
00G		G3/G4/G5	563	569	HE Green	2.3	210mcd@20mA	0.03mW@20mA	GaP/GaP
UPG		PG350	563	564	Super P.Green	2.1	400mcd@20mA	0.6mW@20mA	InGaAlP
0PG		PG5	557	560	Pure Green	2.2	140mcd@20mA	0.2mW@20mA	GaP/GaP
0AG		AG10K	522	528	Aqua Green	3.4	15,000mcd@20mA	30mW@20mA	InGaN
0BG		BG7K	501	502	Blue Green	3.4	4300mcd@20mA	16mW@20mA	InGaN
0PB		PB4KB	455	460	Super Blue	3.2	3000mcd@20mA	61mW@20mA	InGaN
00B		UB500	425	447	Ultra Blue	4.0	250mcd@20mA	5mW@20mA	SiC/GaN
405	UV	UV405	402	420	Ultra Violet	3.8	39mcd@20mA	53mW@20mA	SiC/GaN

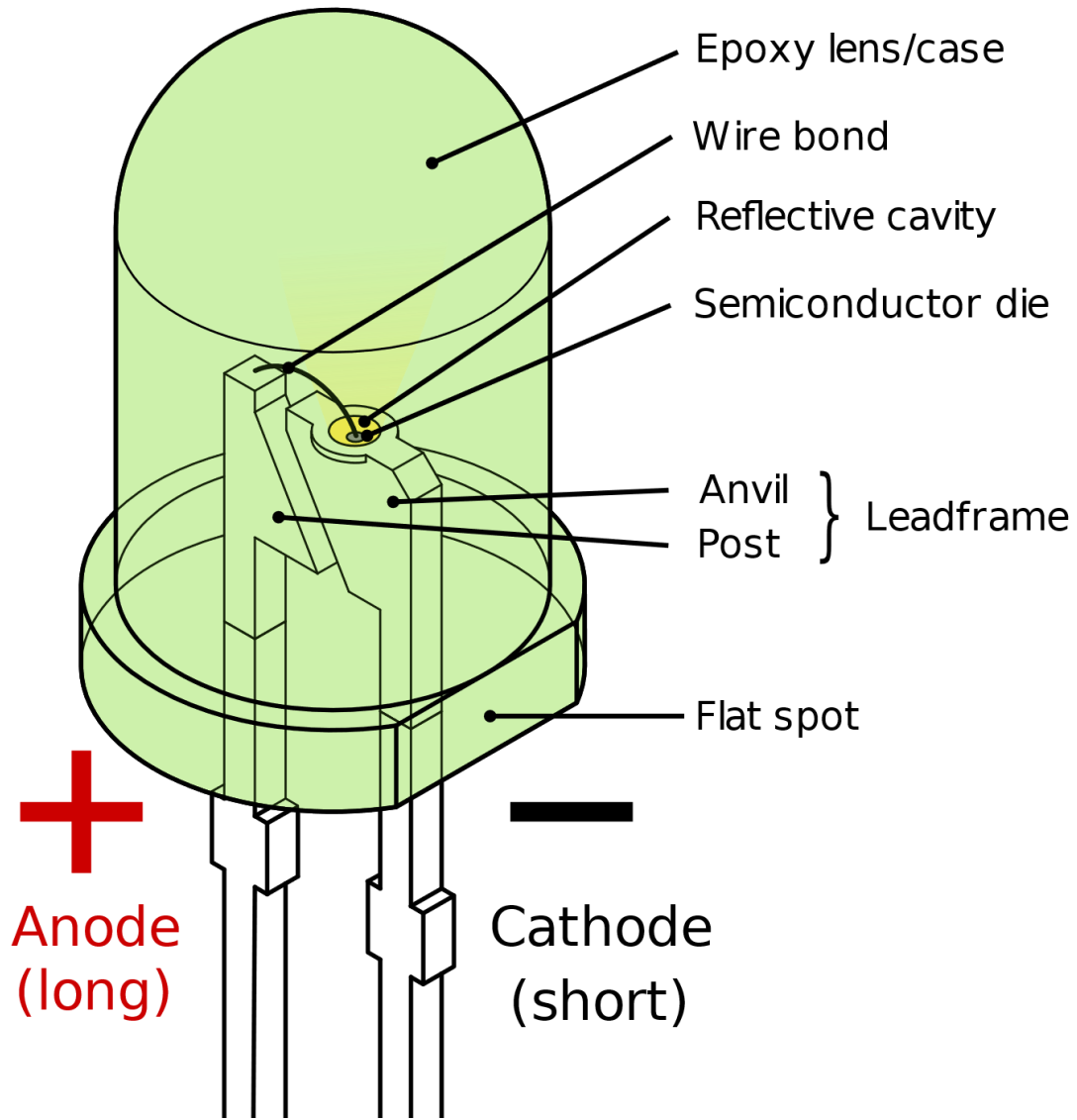

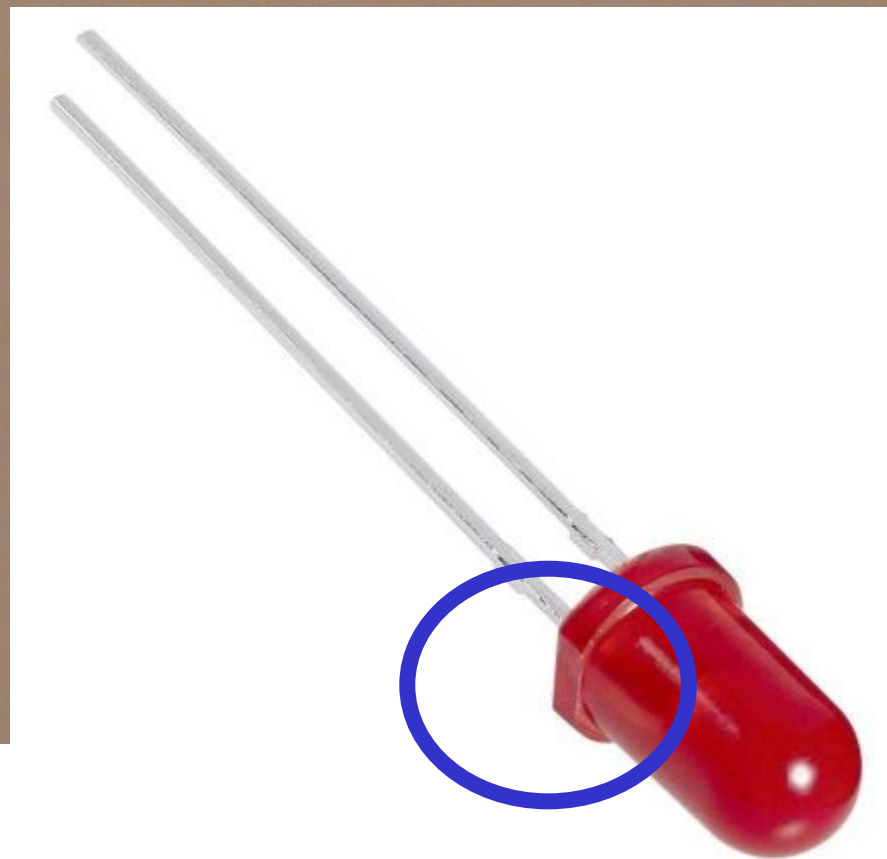
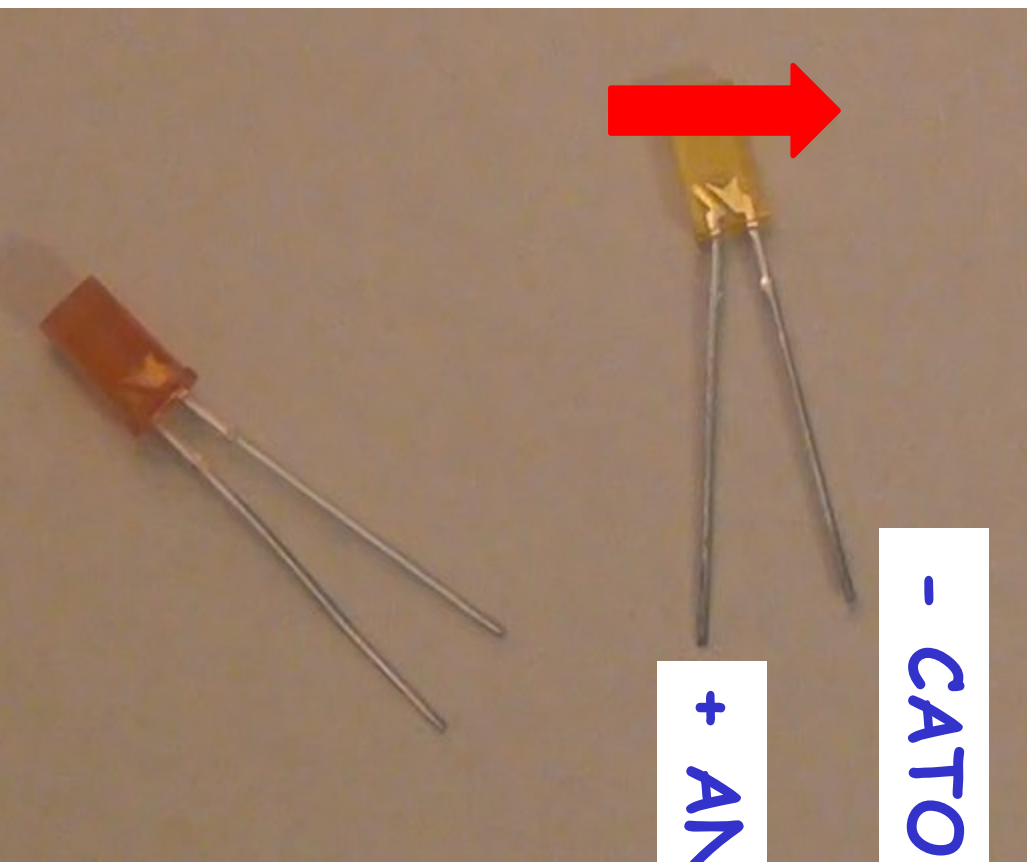

Impieghi principali dei LED

Illuminazione

Segnalazione

Lampadine spia o standby

Lampeggianti

Semafori

Cartellonistica

Dispositivi luminosi obbligatori per veicoli

Comunicazione

Telecomandi a infrarossi

Comunicazioni ottiche a breve distanza

Retroilluminazione display LCD

Affidabilità

Durata

Alta efficienza

(basso consumo)

Impieghi principali dei LED

Illuminazione

Risparmio energetico



Dimostrazione con telecamera infrarossi: misure di temperatura su lampade



Lampada ad incandescenza «Edison»





Principio di funzionamento

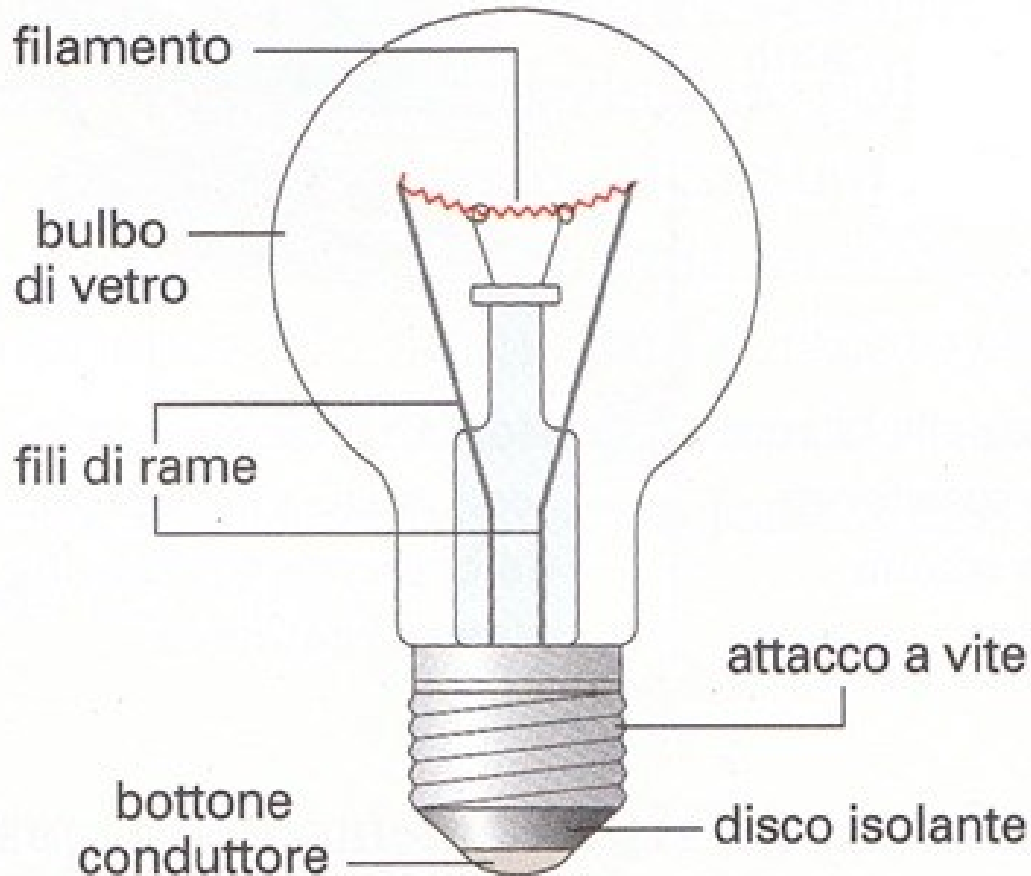

Il filamento di tungsteno si surriscalda ed emette fotoni

Temperatura: 2700 K

Rendimento inferiore al 5%

misura nella regione dell'infrarosso

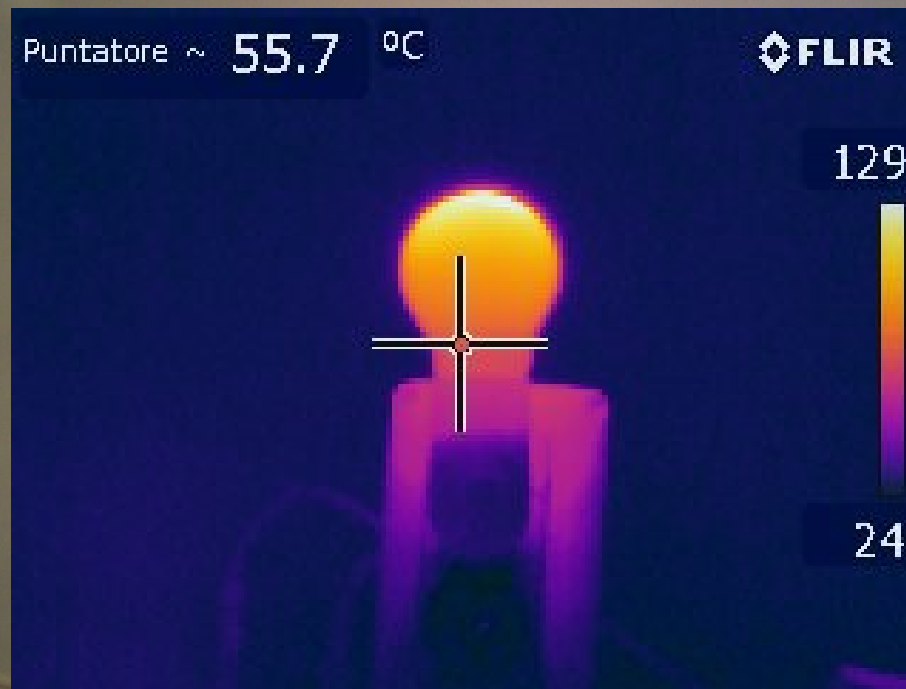



Lampada fluorescente

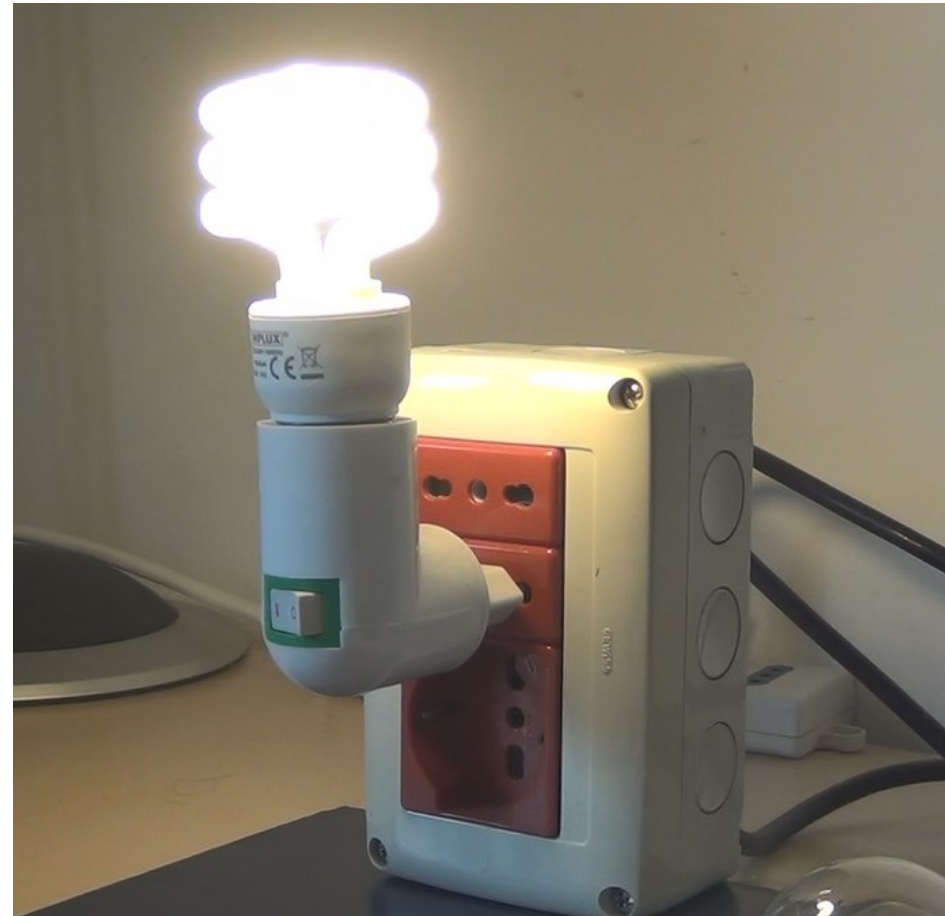

Questa si può toccare (con attenzione)



Principio di funzionamento

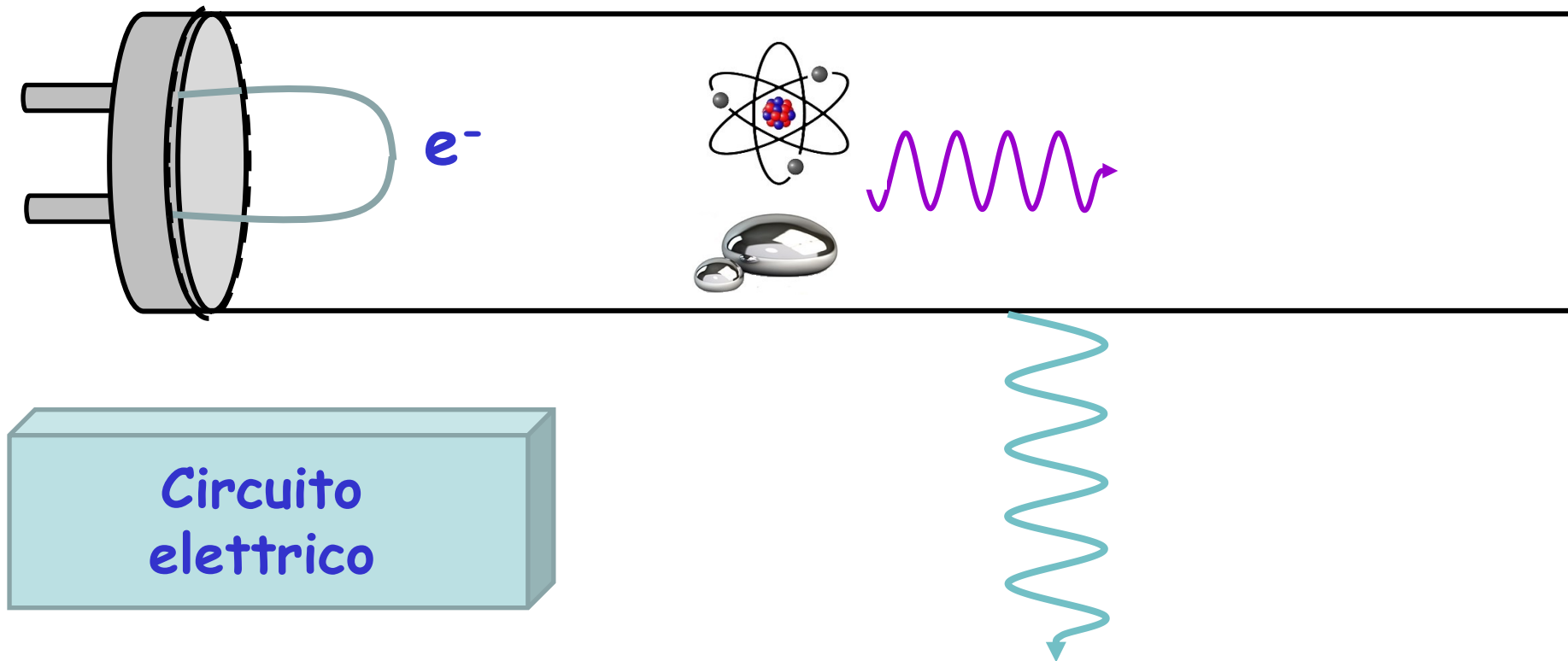

vedi anche: <https://www.youtube.com/watch?v=Da3QEH2IdEE>
(ondivaghiamo arte fluorescente)



misura all'infrarosso

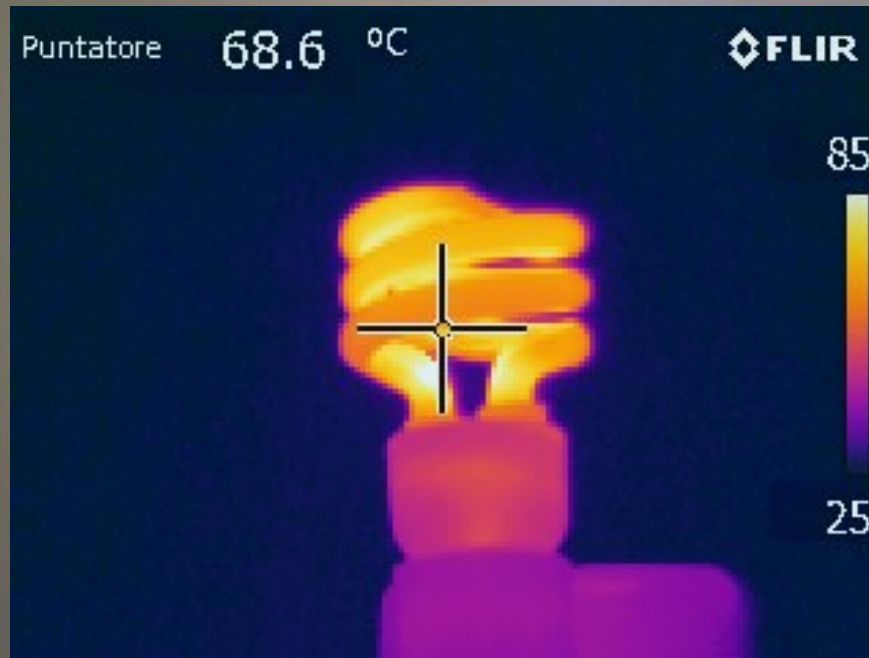

Rendimento
dal 35 al 40%



Lampada a LED





Principio di funzionamento lampada LED





dentro

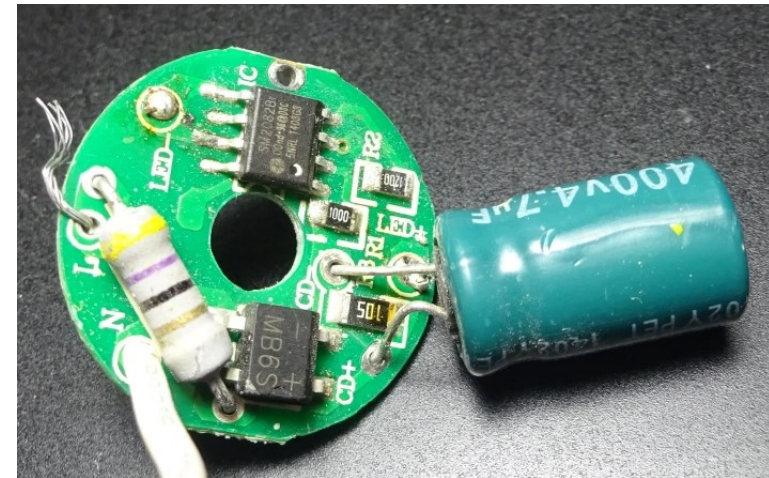



Illuminazione LED

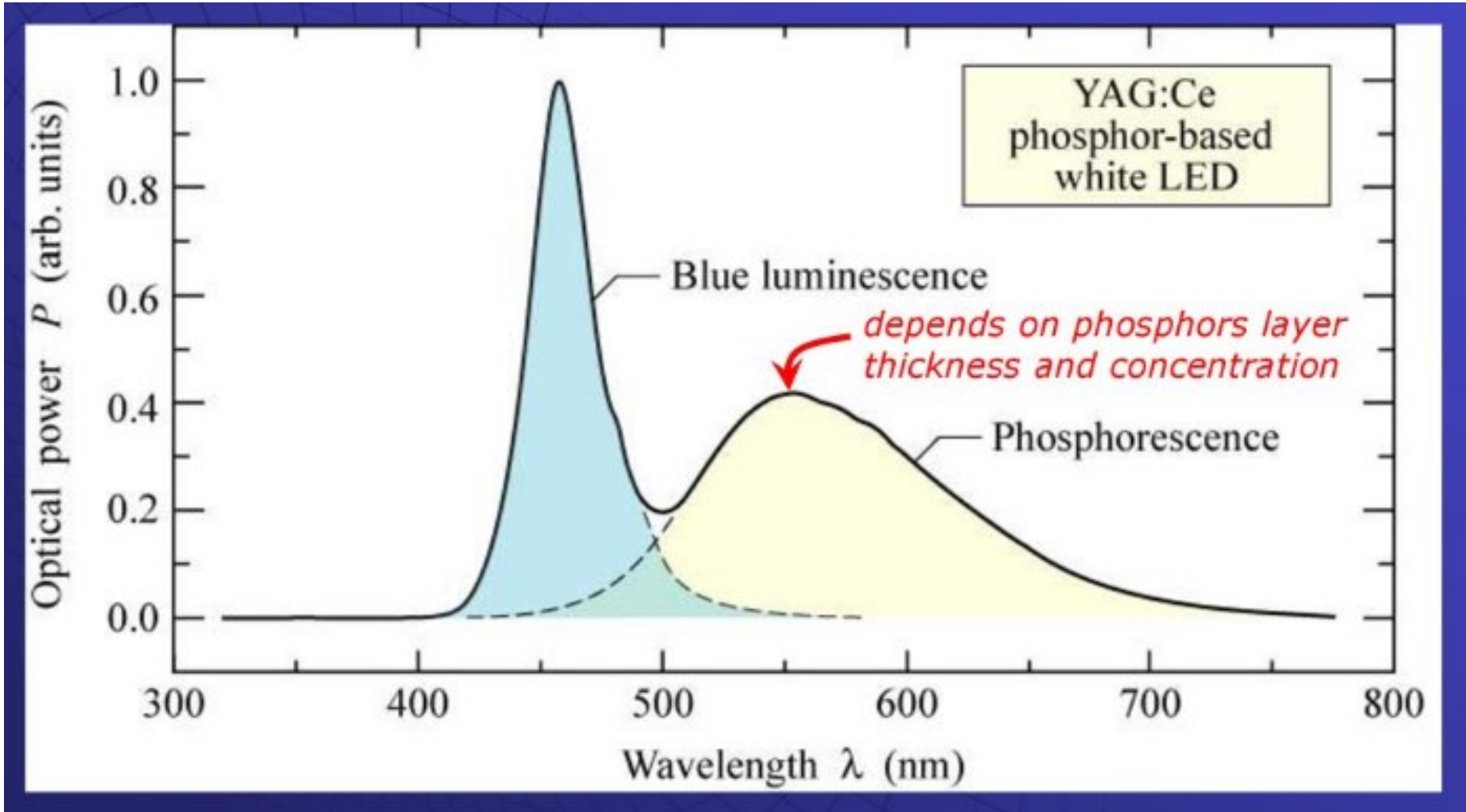



misura all'infrarosso LED

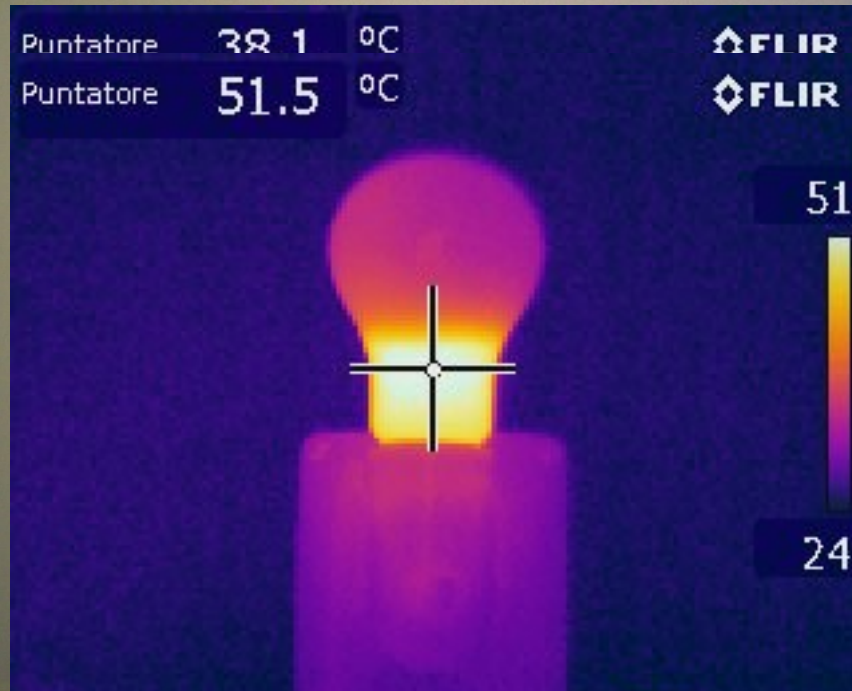

Rendimento
dal 40 al 65%

Impieghi principali dei LED

Illuminazione

Segnalazione

Lampadine spia o standby

Lampeggianti

Semafori

Cartellonistica

Dispositivi luminosi obbligatori per veicoli

Comunicazione

Telecomandi a infrarossi

Comunicazioni ottiche a breve distanza

Retroilluminazione display LCD

Affidabilità

Durata

Alta efficienza

(basso consumo)

Dimostratore comunicazione ottica a breve distanza

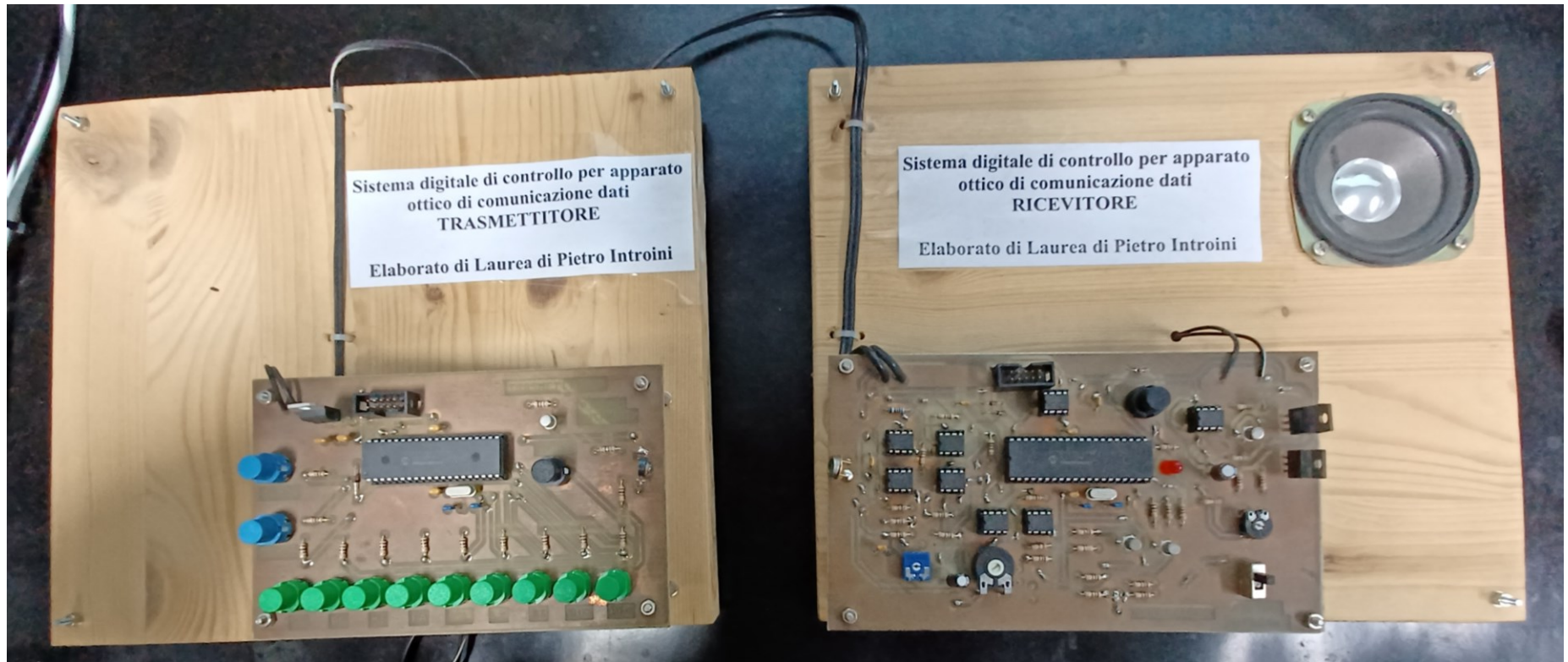

Esperienza con i LED ma prima....

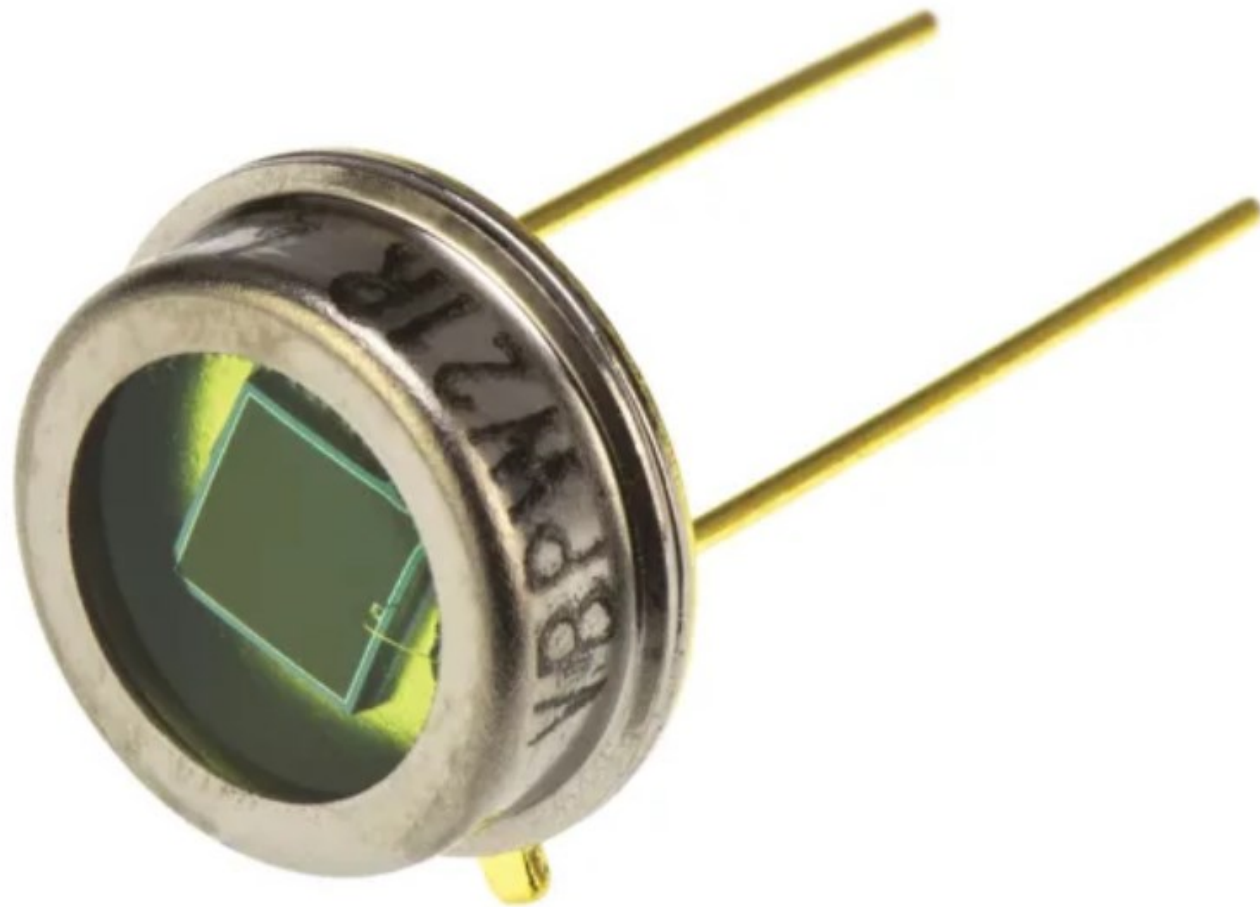

Dispositivi Optoelettronici: principi fisici

Fotoconduttività (fotoresistore, tubo a camera fotoconduttiva, charge-coupled imaging devices)

Effetto Lossev o combinazione radiativa (LED)

Effetto Fotoelettrico o **Fotovoltaico** (fotodiodi, fototransistori, fotomoltiplicatori, circuiti ottici integrati)

Emissione Stimolata (LASER, diodo LASER)

Fotoemissività (tubo a camera fotoemissiva)

Modulazione Elettronica (LCD)

.....

Giunzione p-n

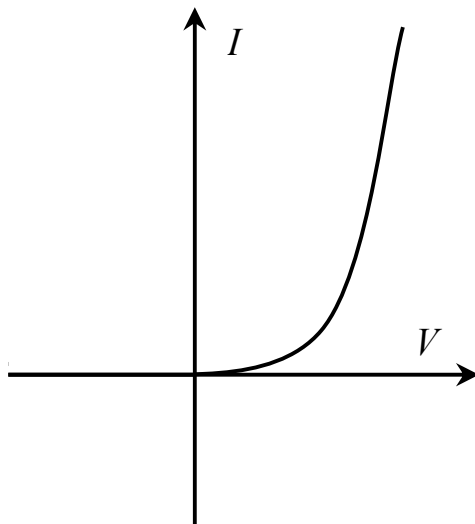
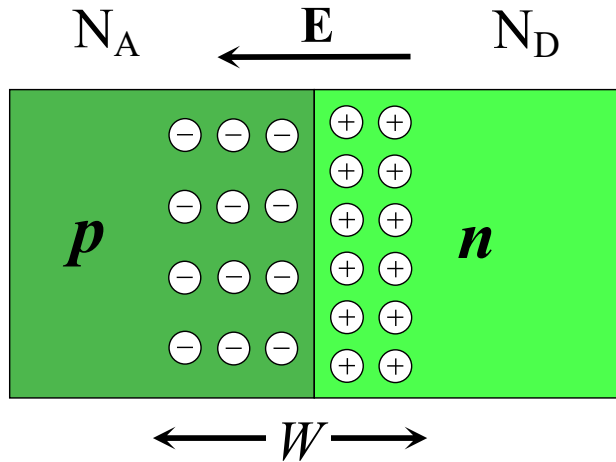

Se la giunzione viene illuminata, si generano coppie elettrone-lacuna sia nella parte p sia nella parte n

Il campo elettrico E divide i portatori: gli elettroni verso n e le lacune verso p

Se si collega un carico esterno, la corrente può fluire

$$I = I_S \left(e^{\frac{qV}{\eta kT}} - 1 \right) - I_{ph}$$

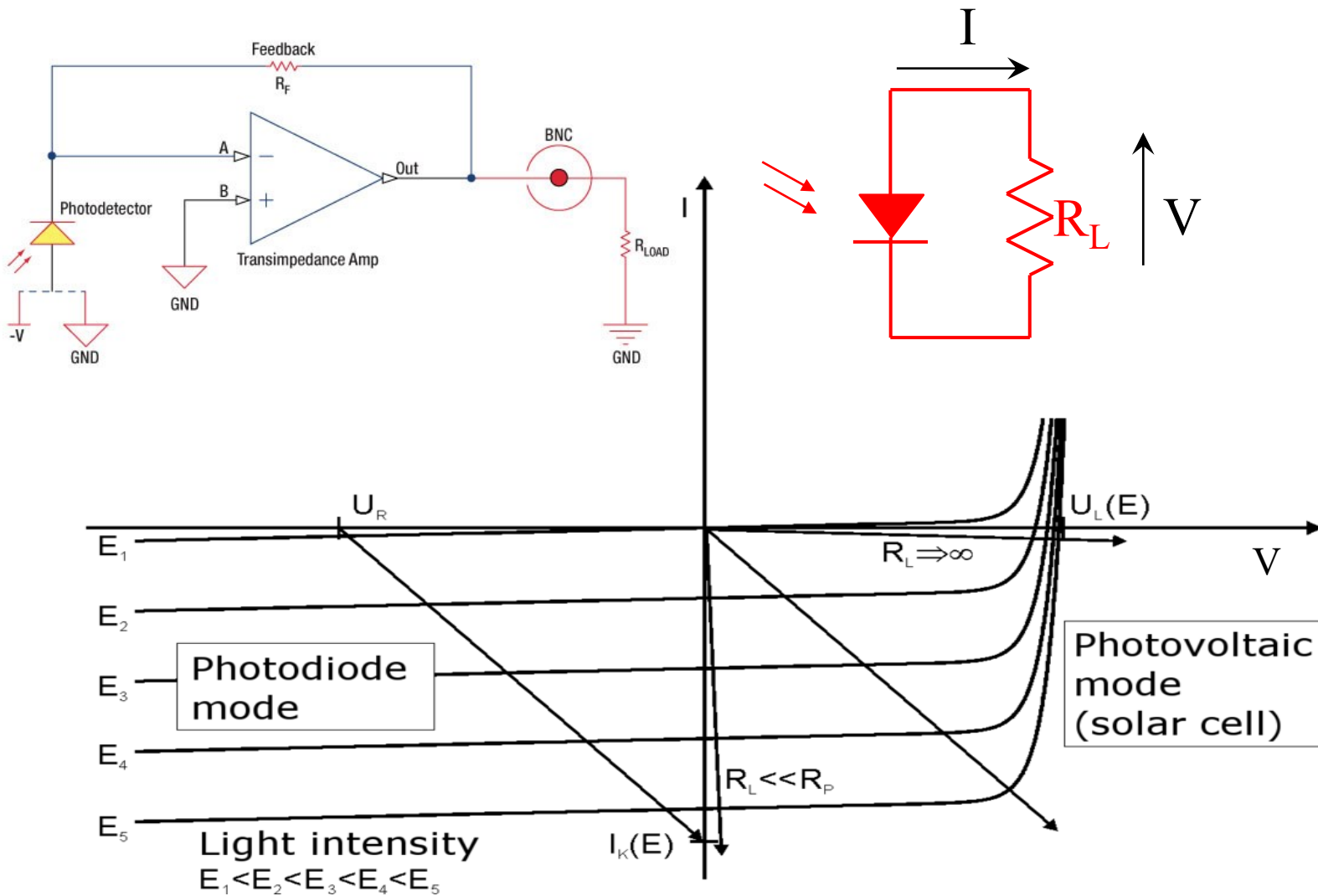

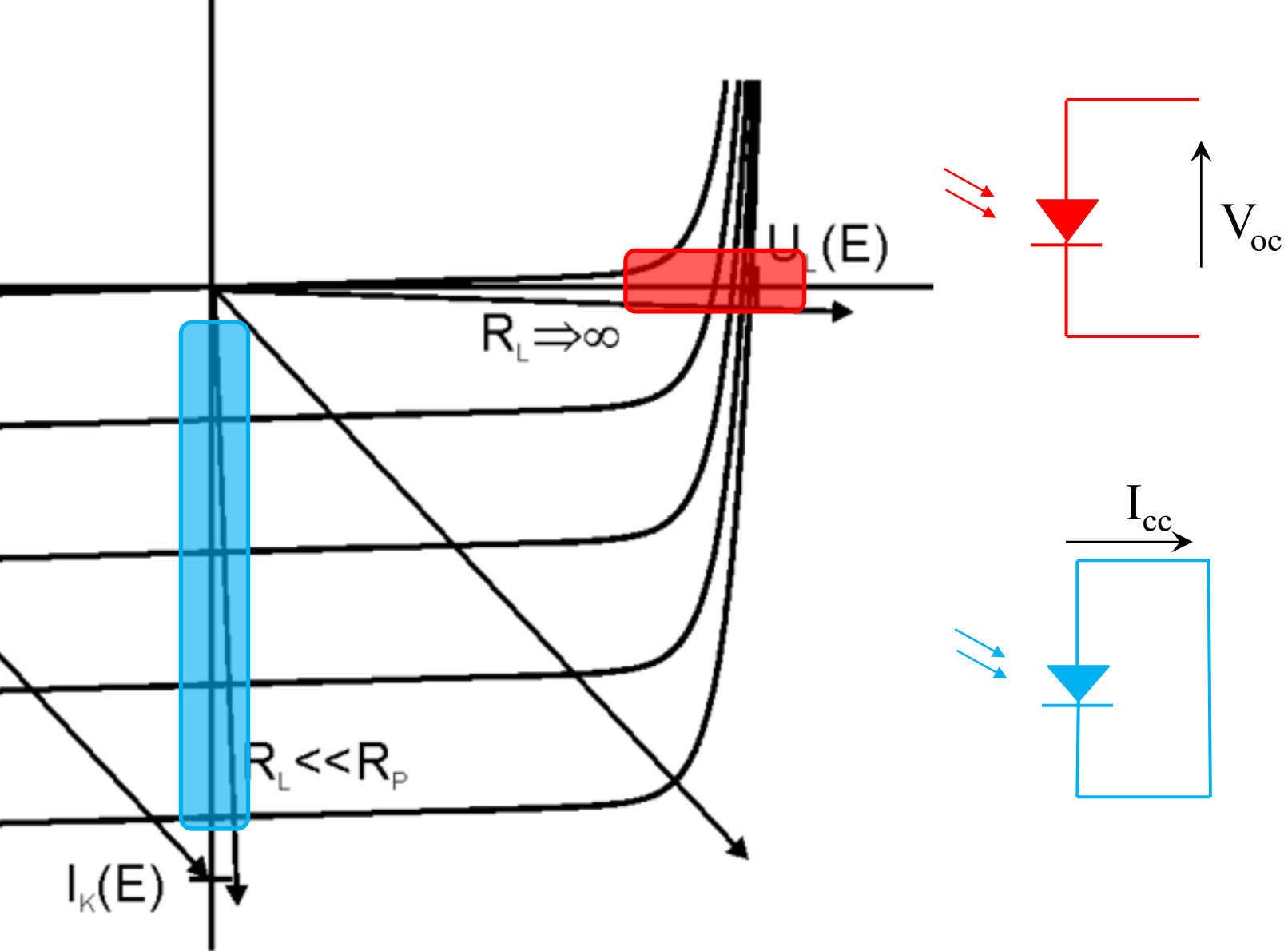



Esperienza di laboratorio: misure di tensione e di corrente su fotorivelatore

MISURA DI TENSIONE ELETTRICA DC VOLTMETRO

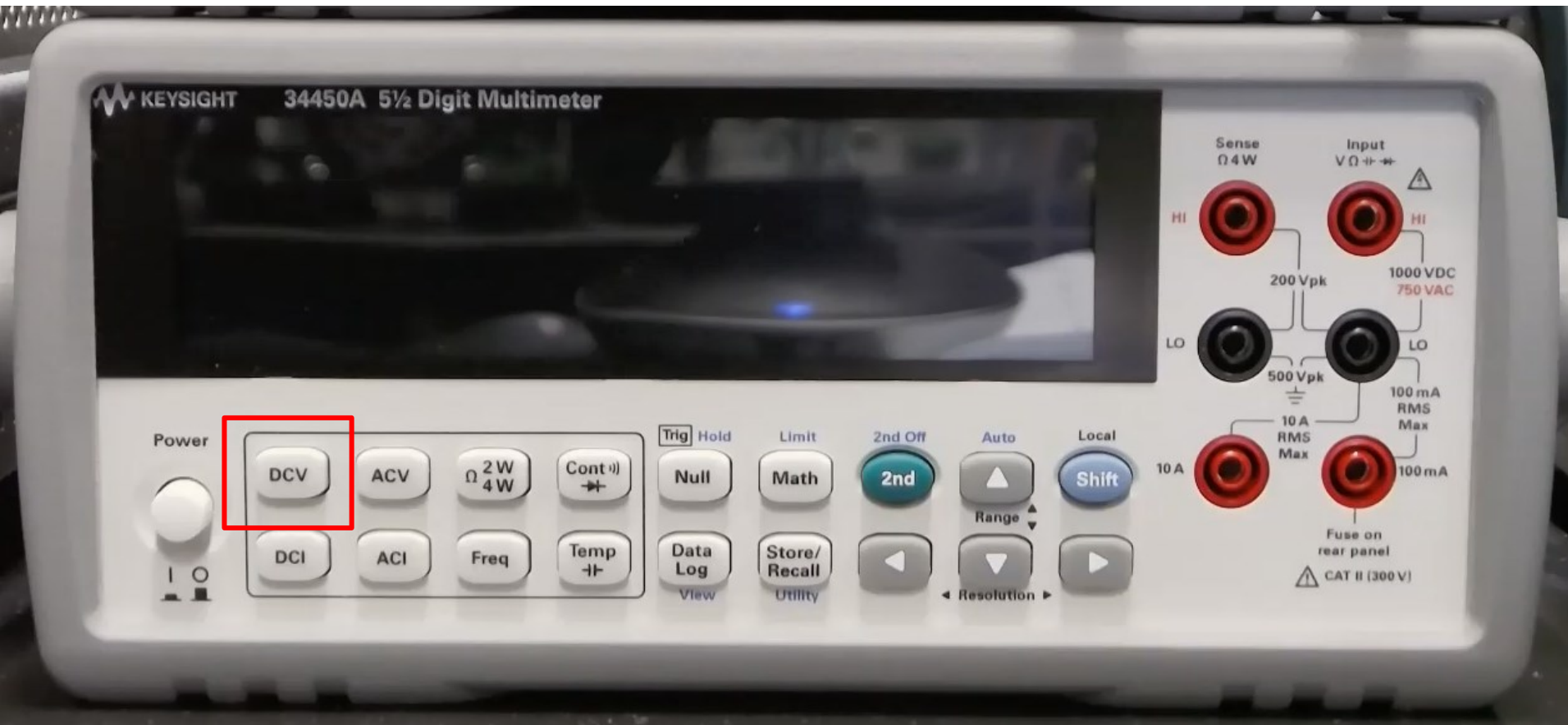



MISURA TENSIONE ELETTRICA



MISURA DI TENSIONE ELETTRICA VOLTMETRO

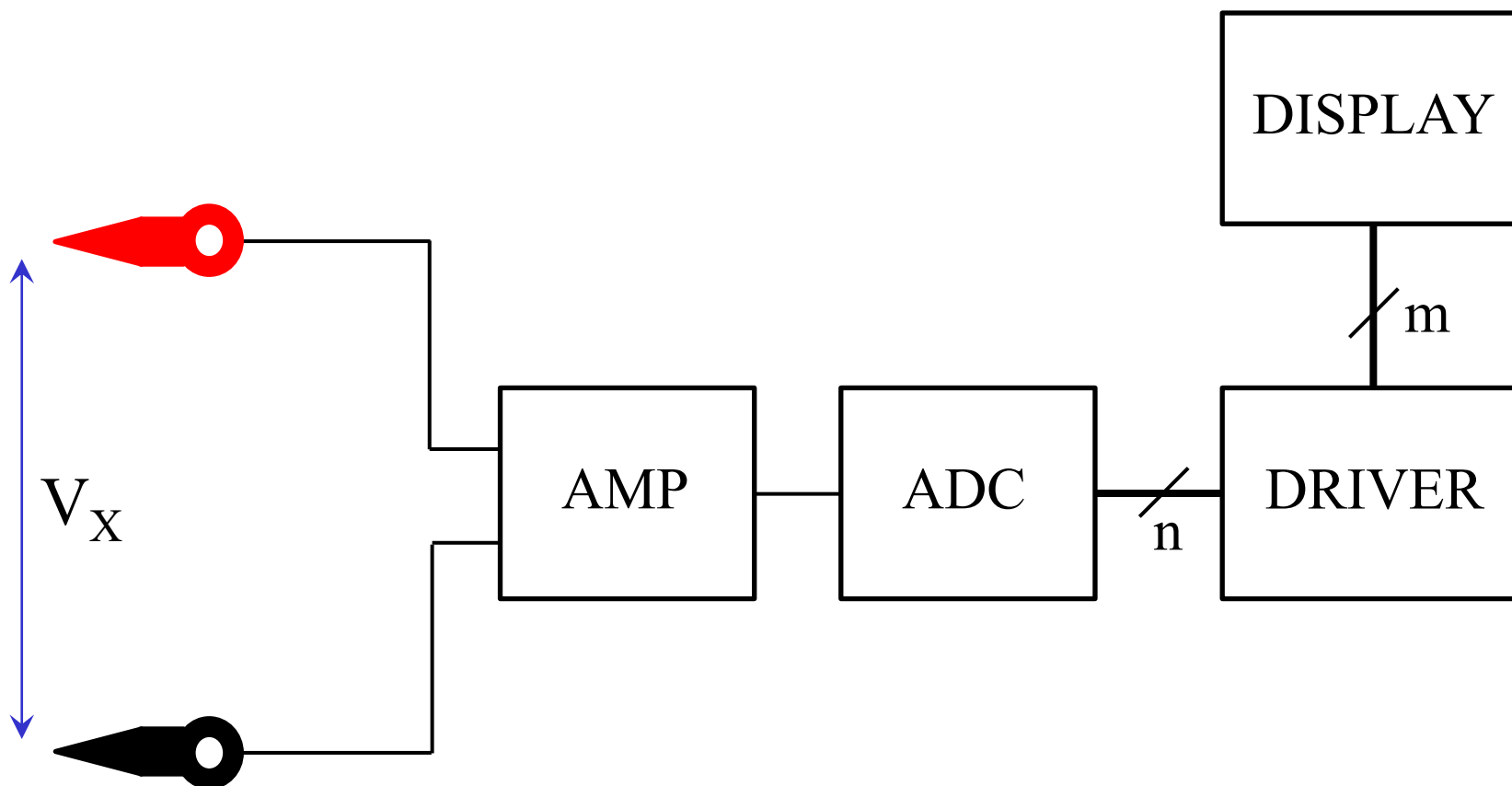



Basetta sperimentale (breadboard)

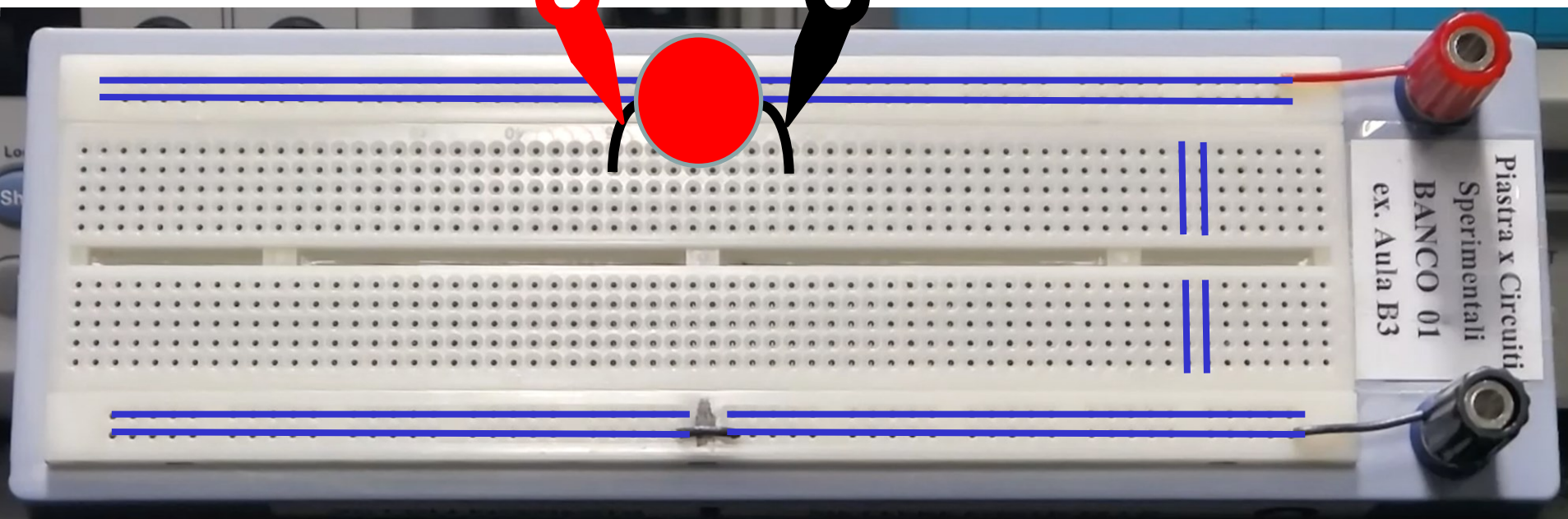

MISURA DI CORRENTE AMPEROMETRO

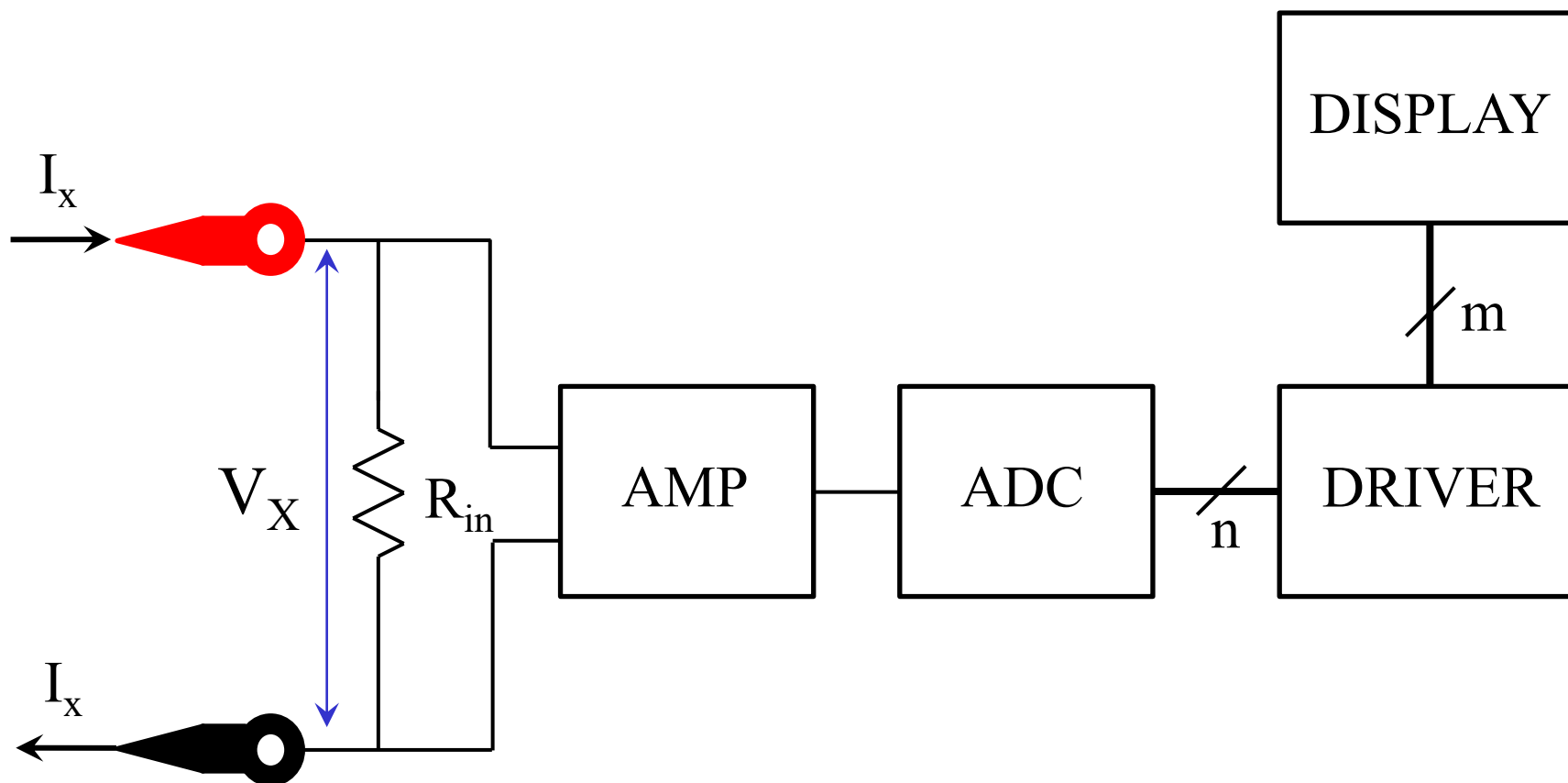



MISURA DI CORRENTE AMPEROMETRO

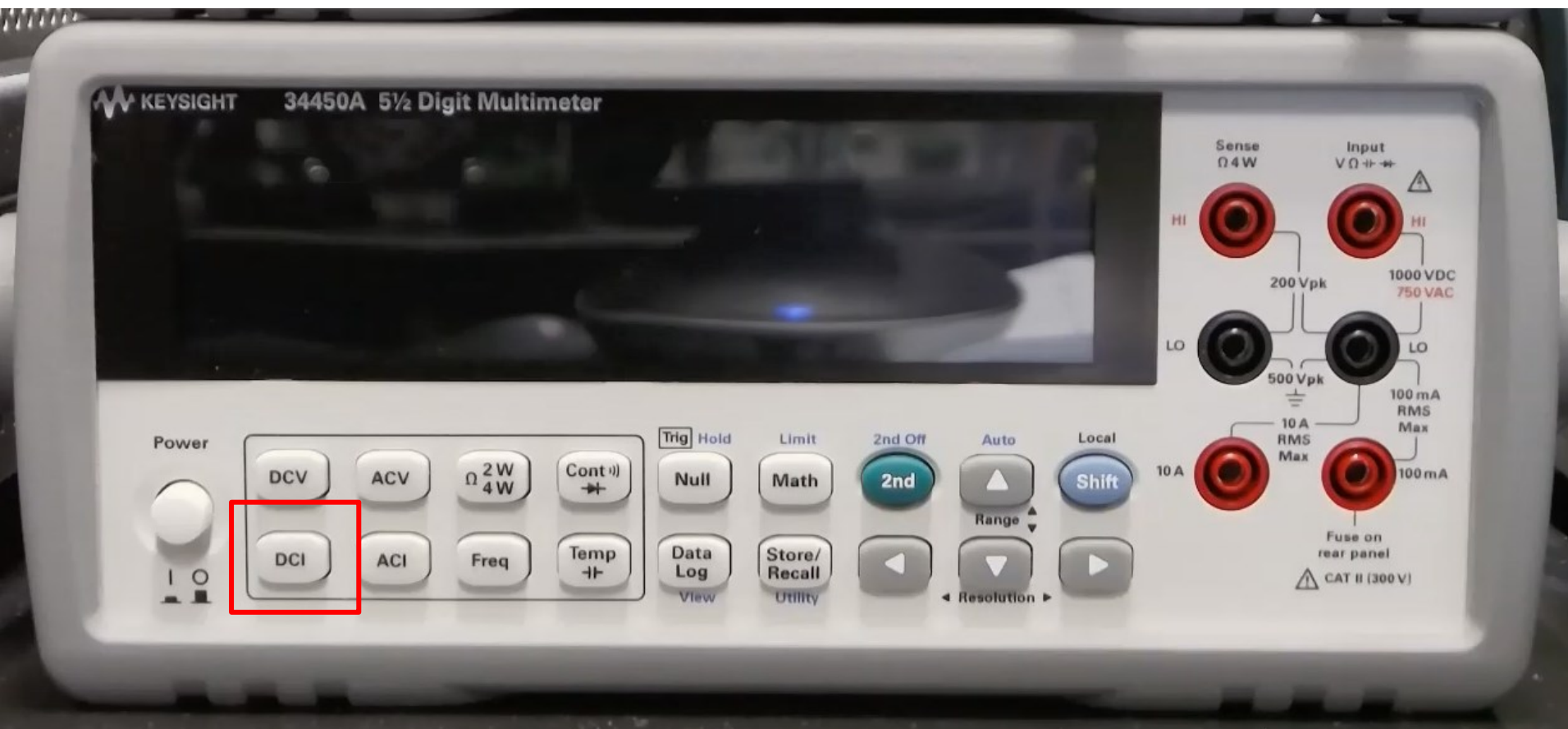



MISURA DI CORRENTE AMPEROMETRO

fino a 100 mA





Basetta sperimentale (breadboard)

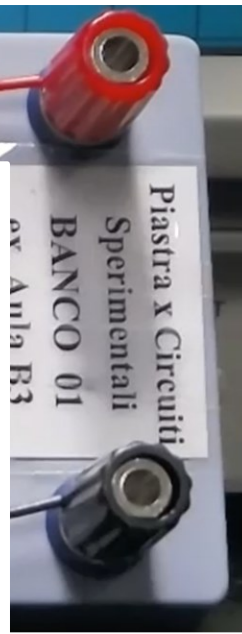
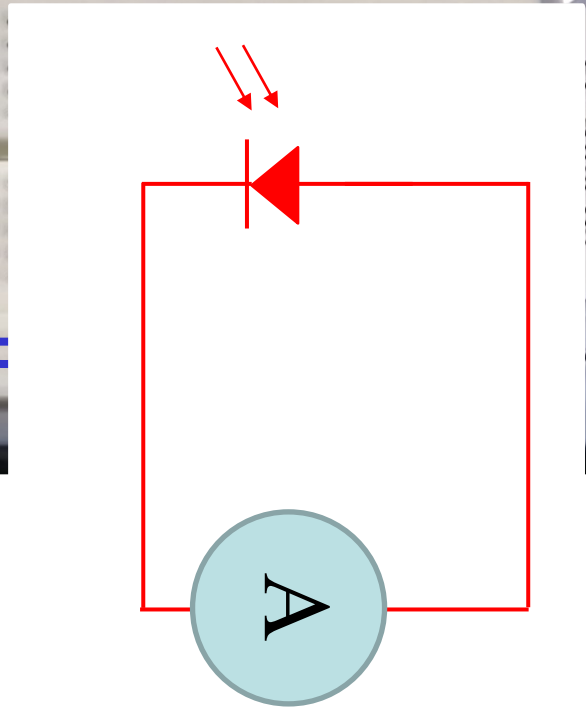
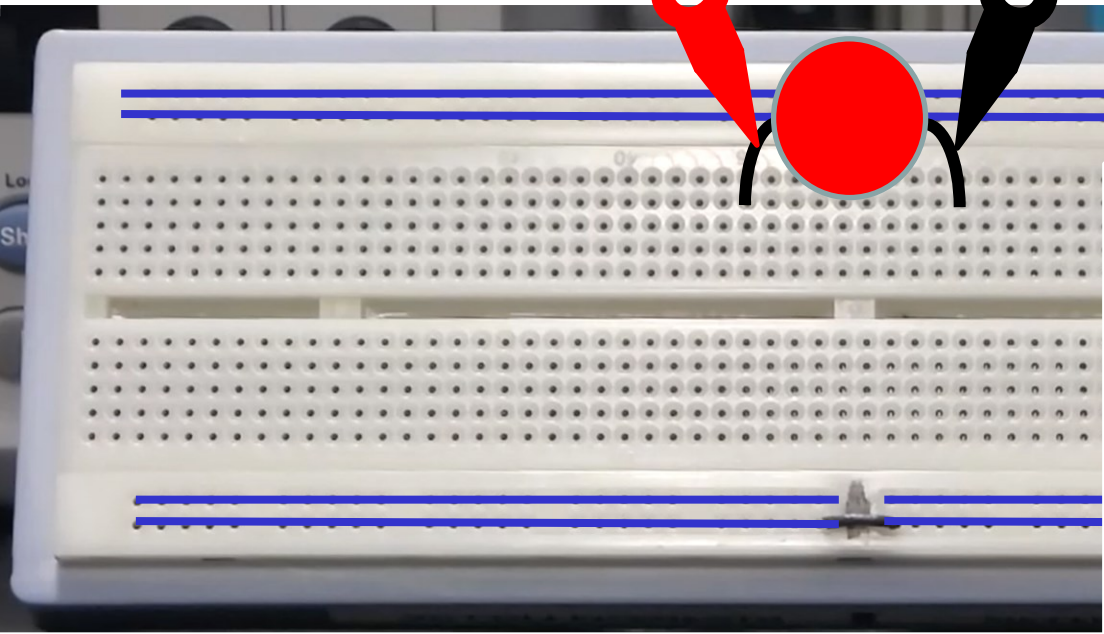
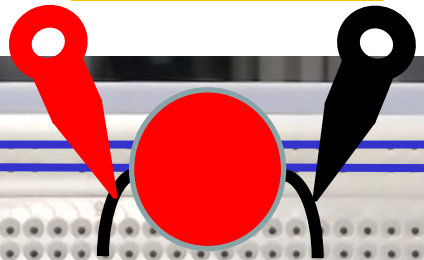
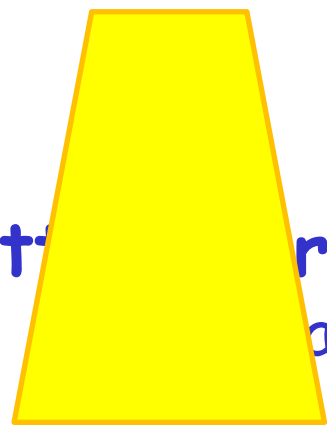

Esperienza di laboratorio: costruzione di un circuito con LED, resistore e batteria



Circuito con LED

R1

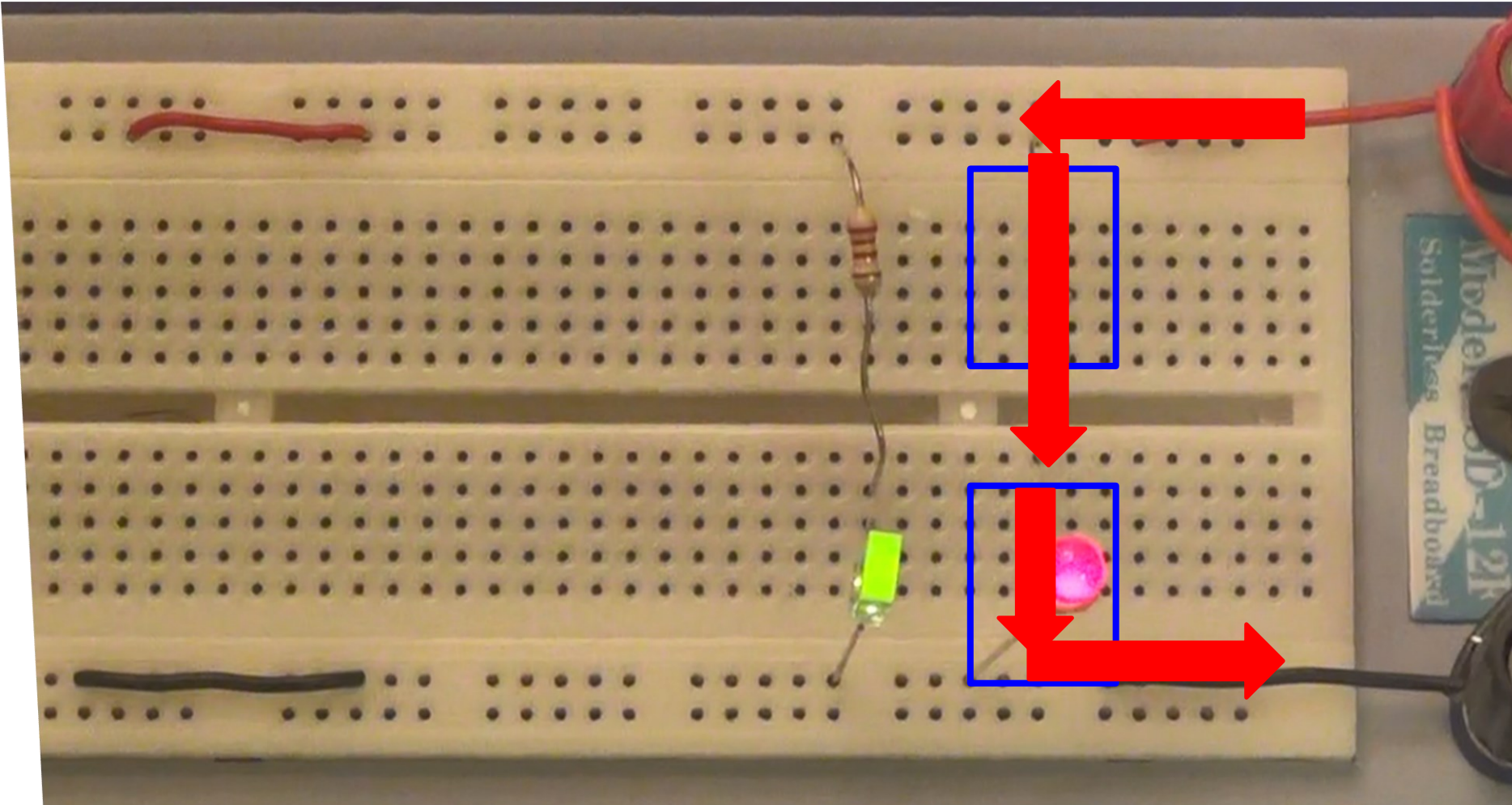

Osservare luminosità con differenti valori di resistenza

(stesso LED, cambiare resistore)

Misurare caduta di tensione ai capi del LED

(stesso resistore, differenti colori dei LED nel visibile, LED UV, LED IR)

		LED Chip Code	Peak Wave length (nm)	Dominant Wave length (nm)	Color Name	Nominal Fwd Voltage (V _f @20ma)	Intensity (mcd) 5mm LEDs (For Reference)	Radiant Power mW/sr	LED Die Material
851	IR	IR851	843	N/A	Infrared	1.7	N/A	86mW@50mA	GaAlAs/GaAs
0UR		R3KF/R6	654	641	Ultra Red	1.9	1000mcd@20mA	13mW@20mA	GaAlAs/GaAlAs
00R		R3/R4/R5	640	625	HE Red	2.0	220mcd@20mA	1.8mW@20mA	GaAsP/GaP
0ER		E3K	634	624	Super E.Red	2.2	8000mcd@20mA	45mW@20mA	InGaAlP
0UO		O3KF	616	610	Super Orange	2.0	2000mcd@20mA	7mW@20mA	InGaAlP
00O		O4/O5	609	604	Orange				
0UY		Y3KF	598	593	Super Yellow				
0PY		Y3KH	592	589	Super P.Yellow				
00Y		Y3/Y4/Y5	582	584	Yellow				
0UG		G1K	575	573	Super L.Green	2.0	1800mcd@20mA	3mW@20mA	InGaAlP
00G		G3/G4/G5	563	569	HE Green	2.3	210mcd@20mA	0.03mW@20mA	GaP/GaP
UPG		PG350	563	564	Super P.Green	2.1	400mcd@20mA	0.6mW@20mA	InGaAlP
0PG		PG5	557	560	Pure Green	2.2	140mcd@20mA	0.2mW@20mA	GaP/GaP
0AG		AG10K	522	528	Aqua Green	3.4	15,000mcd@20mA	30mW@20mA	InGaN
0BG		BG7K	501	502	Blue Green	3.4	4300mcd@20mA	16mW@20mA	InGaN
0PB		PB4KB	455	460	Super Blue	3.2	3000mcd@20mA	61mW@20mA	InGaN
00B		UB500	425	447	Ultra Blue	4.0	250mcd@20mA	5mW@20mA	SiC/GaN
405	UV	UV405	402	420	Ultra Violet	3.8	39mcd@20mA	53mW@20mA	SiC/GaN

Verifica: $E = hv$??

Dispositivi Optoelettronici: principi fisici

Fotoconduttività (fotoresistore, tubo a camera fotoconduttiva, charge-coupled imaging devices)

Effetto Lossev o combinazione radiativa (LED)

Effetto Fotoelettrico o Fotovoltaico (fotodiodi, fototransistori, fotomoltiplicatori, circuiti ottici integrati)

Emissione Stimolata (LASER, diodo LASER)

Fotoemissività (tubo a camera fotoemissiva)

Modulazione Elettronica (LCD)

.....

Dispositivi Optoelettronici: principi fisici

Fotoconduttività (fotoresistore, tubo a camera fotoconduttiva, charge-coupled imaging devices)

Effetto Lossev o combinazione radiativa (LED)

Effetto Fotoelettrico o Fotovoltaico (fotodiodi, fototransistori, fotomoltiplicatori, circuiti ottici integrati)

Emissione Stimolata (LASER, diodo LASER)

Fotoemissività (tubo a camera fotoemissiva)

Modulazione Elettronica (LCD)

.....

Liquid Crystal Display (LCD)



Polarizzatore

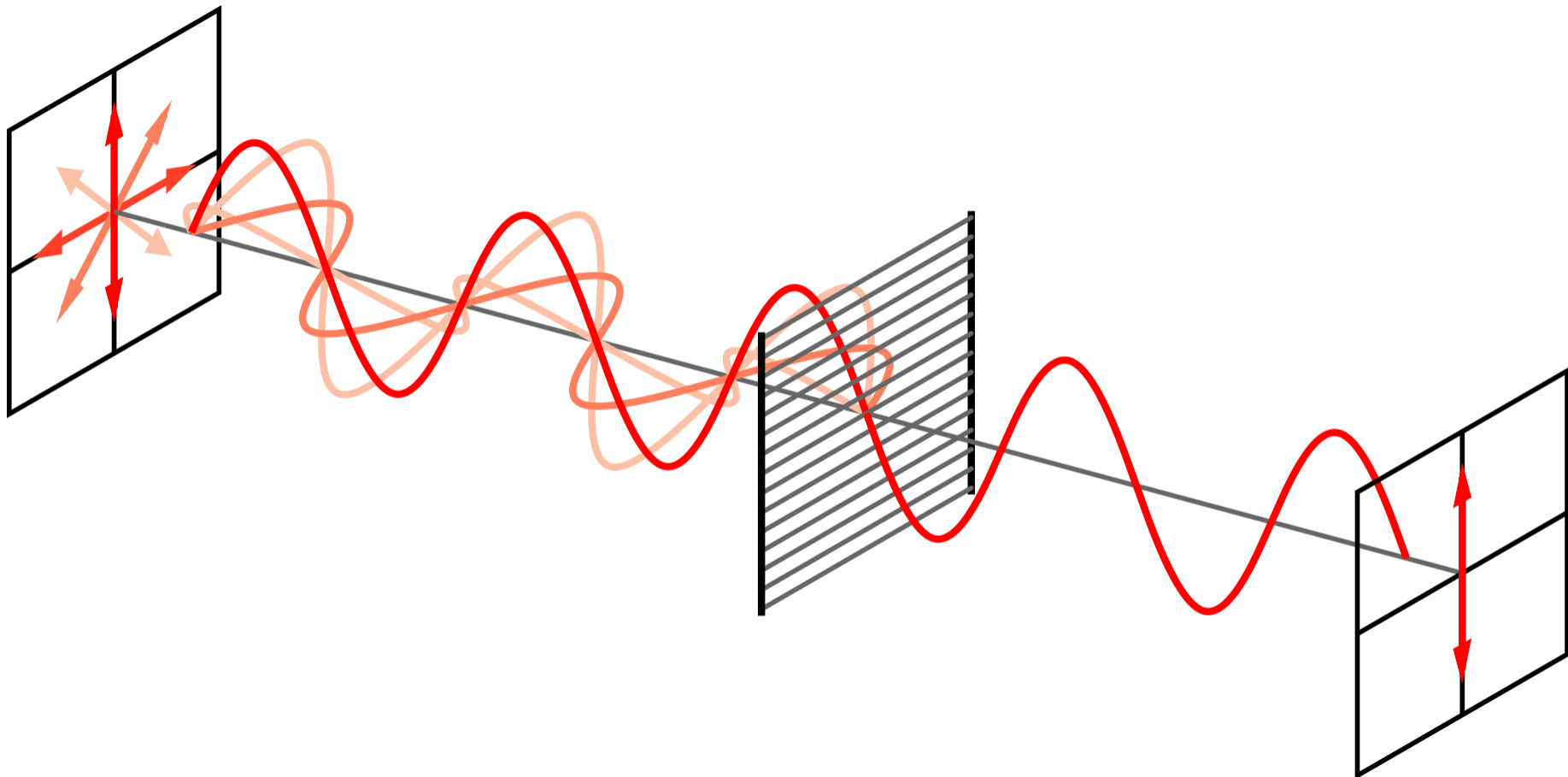

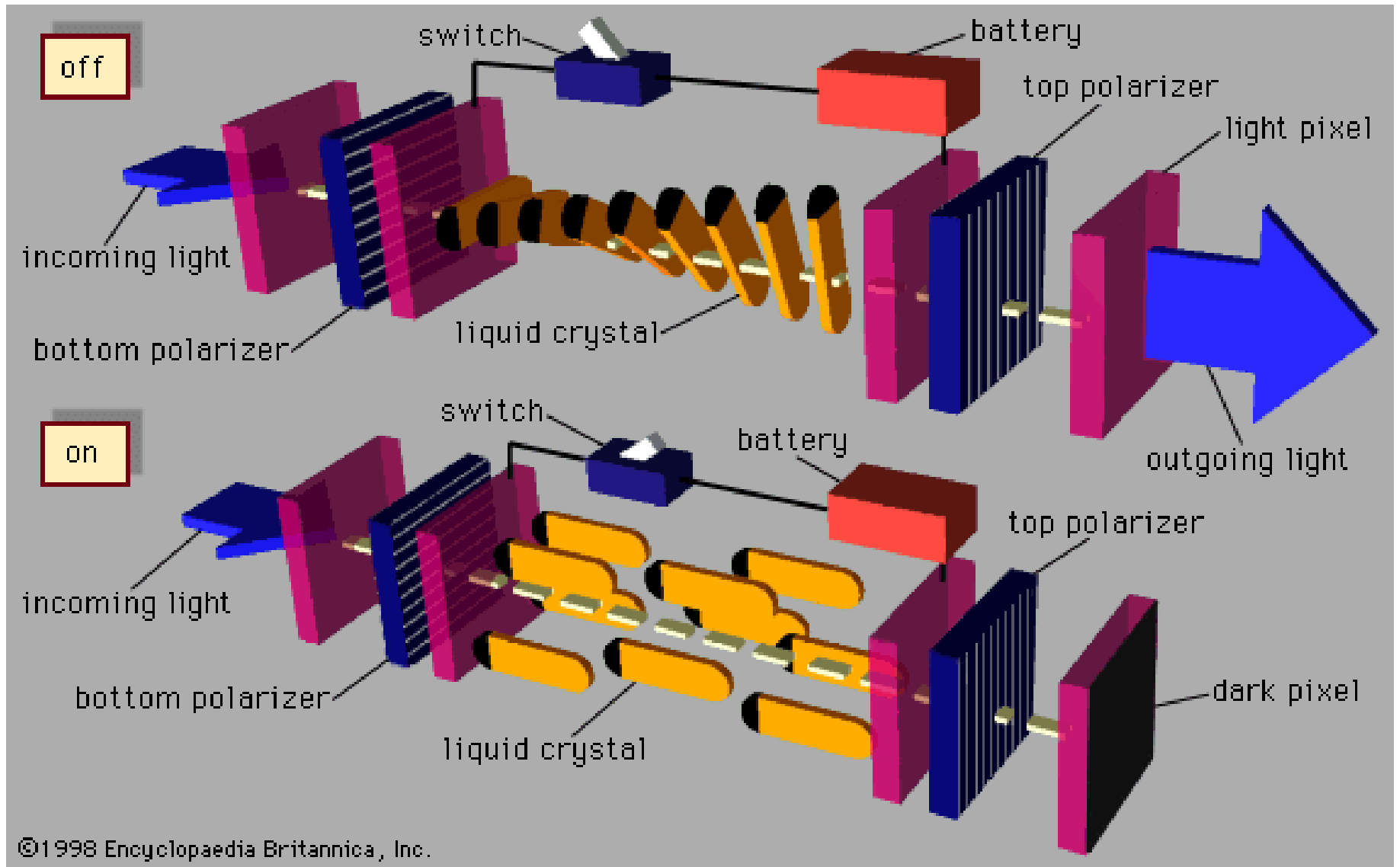

©1998 Encyclopaedia Britannica, Inc.

Unenergized Energized

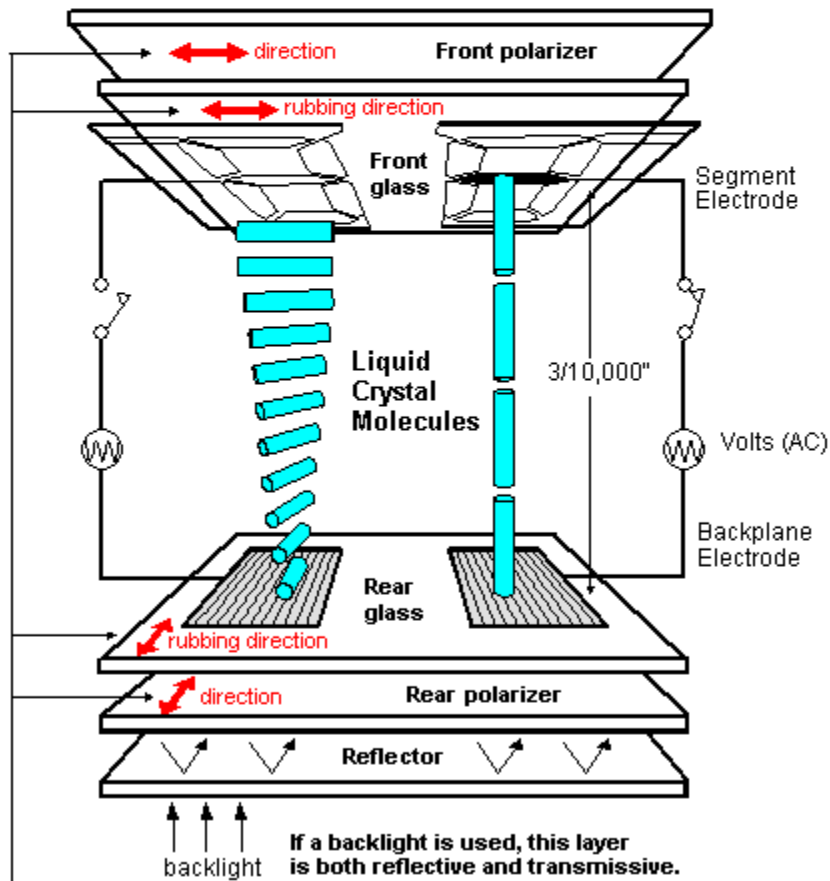
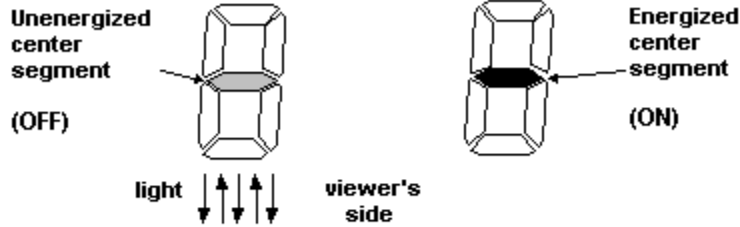

Front and rear orientations at 90 degrees to each other.
Rubbings and polarizers are "crossed."

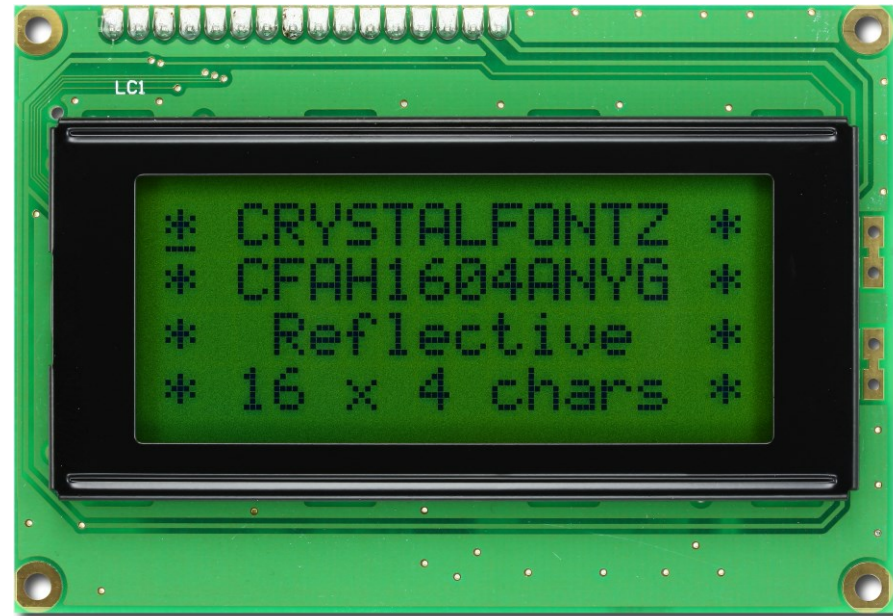

Esperienza di laboratorio: osservazione schermi con polarizzatore

LCD

OLED (elettroluminescenza)



La polarizzazione della luce



izzazione
ice

2013



seguito.....

CEL Laboratorio_03a_GeneratoreSegnali.pptx

CEL Laboratorio_03b_Oscilloscopio.pptx

CEL Laboratorio_03c_LED_lampeggiante